

# **IRC** electronic components

**RESISTORS**

**DIODES**

**CONTROLS**

**TRIMMERS**

**SWITCHES**

**RECORDING TAPE**

**ELECTRICAL TAPE**

**REFERENCE BOOKS**



# CONTENTS



Page	
2	CARBON COMPOSITION RESISTORS
3	MOLDED WIREWOUND RESISTORS
4	RESISTOR KITS AND ASSORTMENTS
6	TUBULAR POWER WIREWOUND RESISTORS
7	ADJUSTABLE AND MILITARY POWER RESISTORS
8	POWER AND FUSE RESISTORS
9	DUAL DIODES
10	PRECISION WIREWOUND RESISTORS
11	PRECISION DEPOSITED CARBON RESISTORS
12	SNAPTROL
17	SNAPTROL DEALER STOCKS
18	SNAPTROL/SERIES 45 INDUSTRIAL CONTROLS
20	SNAPTROL/SERIES 45 INDUSTRIAL CONTROL STOCKS
21	CONCENTRIKIT TYPE Q
23	TYPE 4W CONTROLS AND BASE ELEMENTS
24	CONCENTRIKIT TYPE Q AND 4W PARTS
26	CONCENTRIKIT FOR CONCENTRIC DUALS
27	CONCENTRIKIT EXACT DUPLICATE SHAFT SPECIFICATIONS
28	AUTO RADIO BUSHINGS AND TAPER CHART
29	CONCENTRIKIT DEALER STOCKS
30	INDUSTRIAL Q CONTROL
31	INDUSTRIAL 4W CONTROLS
32	CARBON AND WIREWOUND TRIMMERS
33	CARBON AND WIREWOUND CONTROLS
34	MILITARY CONTROLS
36	INDUSTRIAL VARIABLE RESISTORS
37	AUTO RADIO CONTROLS
38	SPECIAL PURPOSE CONTROLS
40	ROTARY SELECTOR SWITCHES
43	ROTARY SELECTOR SWITCH ACCESSORIES
44	KODAK SOUND RECORDING TAPES
45	VINYL ELECTRICAL TAPE
46	CONTROL CLEANER
47	DIODE AND TRANSISTOR REFERENCE BOOKS
48	INDEX



# CARBON COMPOSITION RESISTORS

## TYPE GBT CARBON COMPOSITION RESISTORS

### PERFORMANCE CHARACTERISTICS

These are shown in relation to MIL-R-11 specification limits on the following two pages. A performance span or range is given for each important characteristic. You know in advance the typical limits within which IRC carbon composition resistors can be expected to perform.

The performance data are based on many thousands of individual tests made on random samples taken from production. The resistors are tested to MIL-R-11, and to other tests of greater severity.

### APPEARANCE

IRC carbon composition resistors have a glossy brown, smooth body. The molded jacket has close dimensional tolerances for trouble-free use in high speed lead forming and inserting machines. There is no wax coating to clog equipment.

### IDENTIFICATION

Resistance values are clearly indicated by standard EIA/MIL Color Code bands. Solvent-resistant paints are baked on to provide distinct, permanent color bands.

### STANDARD RESISTANCE VALUES

Type GBT resistors are supplied in all EIA/MIL standard values, subject to the minimum and maximum values for each type. (See table.) Other values are available on special order.

### EIA/MIL COLOR CODE

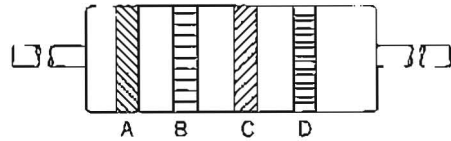

- Band A—1st significant figure
- Band B—2nd significant figure
- Band C—Number of zeros or decimal multiplier
- Band D—Tolerance

Color	Significant Figure	Multiplying Value
Black	0	1
Brown	1	10
Red	2	100
Orange	3	1,000
Yellow	4	10,000
Green	5	100,000
Blue	6	1,000,000
Violet	7	10,000,000
Gray	8	100,000,000
White	9	1,000,000,000
Gold	±5% tolerance	
Silver	±10% tolerance	0.1
No color	±20% tolerance	0.01

### FIXED COMPOSITION RESISTORS.



IRC's unique design of 1/4-, 1/2- and 1-watt resistors means better performance and reliability. 50% more molding around the resistance element assures greater moisture protection. The working element is a layer of carbon thermally bonded to an inert glass filament for better resistance and temperature characteristics. Ribbed, shoulder leads are deeply imbedded in the molding to prevent twist or pull-out and act as heat sinks to conduct heat away for cooler operation and longer field life.

IRC TYPE	GBT 1/4 - SR 1/4	GBT 1/2	GBT 1	SR 2
MIL Style	RC07	RC20	RC32	RC42
MIL Characteristic	GF	GF	GF	GF
Rating	1/4w @ 70° amb.	1/2w @ 70° amb.	1w @ 70° amb.	2w @ 70° amb.
Minimum Resistance	10 ohms	2.7 ohms	2.7 ohms	10 ohms
Maximum Resistance	1 meg	22 meg	22 meg	22 meg
Rated Voltage	250V	350V	500V	500V
Dimensions—				
Body size	.250" x .090" dia.	.390" x .140" dia.	.562" x .225" dia.	1 1/4" x .312" dia.
Lead size	1 1/2" x .025" dia.	1 1/2" x .031" dia.	1 1/2" x .040" dia.	1 1/2" x .045" dia.

### STANDARD STOCK VALUES

10% and 5% tolerance. 10% in bold type. All values available in 5%. Values are indicated on each resistor by EIA color code.

2.7	10	39	150	560	2,200	8,200	33K	120K	470K	1.8 meg.	6.8 meg.
3.0	11	43	160	620	2,400	9,100	36K	130K	510K	2.0 meg.	7.5 meg.
3.3	12	47	180	680	2,700	10K	39K	150K	560K	2.2 meg.	8.2 meg.
3.6	13	51	200	750	3,000	11K	43K	160K	620K	2.4 meg.	9.1 meg.
3.9	15	56	220	820	3,300	12K	47K	180K	680K	2.7 meg.	10.0 meg.
4.3	16	62	240	910	3,600	13K	51K	200K	750K	3.0 meg.	11.0 meg.
4.7	18	68	270	1,000	3,900	15K	56K	220K	820K	3.3 meg.	12.0 meg.
5.1	20	75	300	1,100	4,300	16K	62K	240K	910K	3.6 meg.	13.0 meg.
5.6	22	82	330	1,200	4,700	18K	68K	270K	1.0 meg.	3.9 meg.	15.0 meg.
6.2	24	91	360	1,300	5,100	20K	75K	300K	1.1 meg.	4.3 meg.	16.0 meg.
6.8	27	100	390	1,500	5,600	22K	82K	330K	1.2 meg.	4.7 meg.	18.0 meg.
7.5	30	110	430	1,600	6,200	24K	91K	360K	1.3 meg.	5.1 meg.	20.0 meg.
8.2	33	120	470	1,800	6,800	27K	100K	390K	1.5 meg.	5.6 meg.	22.0 meg.
9.1	36	130	510	2,000	7,500	30K	110K	430K	1.6 meg.	6.2 meg.	

# MOLDED WIREWOUND RESISTORS

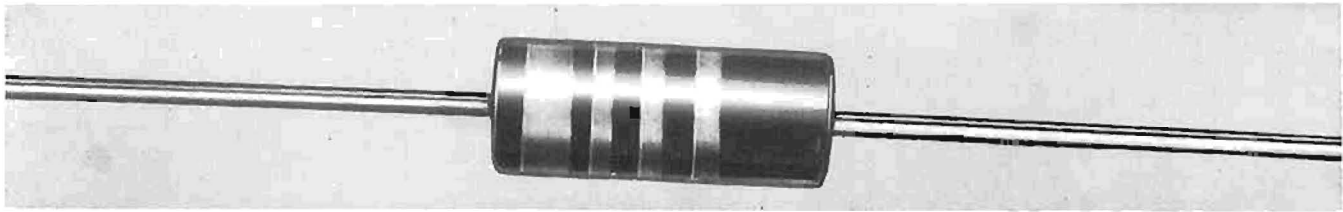

## OUTPERFORMS FIXED COMPOSITION RESISTORS

IRC's new BWH molded wire wound resistor can be used in most applications normally filled by the lower values of composition resistors. The BWH exhibits the inherent stability, reliability, and long-term life characteristics of a wire wound unit. It also provides low resistances unattainable in composition resistors.

Exceptionally stable, small and completely insulated the BWH meets or exceeds all MIL-R-11 performance requirements. Because it is the RC-32 size it will fit any 1 watt composition resistor processing equipment.

BWH resistors are packaged on the exclusive IRC GRIP STRIP, and are available in multiples of 10 and 50.

The rating of this resistor is:

- 1/2 watt at 137°C. ambient
- 1 watt at 115°C. ambient
- 2 watts at 70°C. ambient.

**TOLERANCES & RESISTANCE VALUES.** Available in  $\pm 5\%$  and  $\pm 10\%$  tolerances in accordance with standard EIA resistance values. Minimum standard resistance: 0.24 ohm. Maximum standard resistance: 1500 ohms.

**COLOR CODING.** Resistance values are indicated by standard EIA Color Code bands, and are distinguished from composition resistors by a wide band for the first significant figure.

**INSULATION.** A plastic housing molded with IRC manufactured thermosetting materials at high pressure and temperature results in a high insulation resistance. This protects the element from effects of extreme climatic conditions. Type BWH resistors are brown in color.

**NOISE.** Negligible.

**SHELF DRIFT.** Negligible

## PERFORMANCE SPECIFICATIONS

Temperature Coefficient. (-55°C to 150°C)

$\pm 0.065\%/^{\circ}\text{C}$	$\pm 0.030\%/^{\circ}\text{C}$
0.24 ohm to 1.0 ohm	1.1 ohms to 1500 ohms

In order to cover a wide range of resistance values, it is necessary to use different wire alloys, which have different temperature coefficients of resistance. The above table gives the maximum temperature coefficient within a particular resistance group.

**Inductance.** From 0.04 $\mu\text{h}$  (0.24 ohm resistor) to 5.0 $\mu\text{h}$  (1000 ohm resistor).

**Dielectric Withstanding Voltage.** 1000 volts rms minimum at atmospheric pressure. 625 volts rms minimum at barometric pressure of 3.4 inches of mercury.

STANDARD STOCK VALUES ( $\pm 5\%$ and $\pm 10\%$ tolerance) ( $\pm 10\%$ tolerance in bold type. All values available in $\pm 5\%$ )				
OHMS	OHMS	OHMS	OHMS	OHMS
—	1.0	10	100	1,000
—	1.1	11	110	1,100
—	1.2	12	120	1,200
—	1.3	13	130	1,300
—	1.5	15	150	1,500
—	1.6	16	160	—
—	1.8	18	180	—
—	2.0	20	200	—
—	2.2	22	220	—
0.24	2.4	24	240	—
0.27	2.7	27	270	—
0.30	3.0	30	300	—
0.33	3.3	33	330	—
0.36	3.6	36	360	—
0.39	3.9	39	390	—
0.43	4.3	43	430	—
0.47	4.7	47	470	—
0.51	5.1	51	510	—
0.56	5.6	56	580	—
0.62	6.2	62	620	—
0.68	6.8	68	680	—
0.75	7.5	75	750	—
0.82	8.2	82	820	—
0.91	9.1	91	910	—

Low Temperature Operation.  $\pm 3\%$  maximum.

Temperature Cycling.  $\pm 3\%$  maximum.

Moisture Resistance.  $\pm 6.5\%$  maximum (load or no load).

Short Time Overload. (8 watts for 5 seconds)  $\pm 3.0\%$  maximum.

Load Life. (After 1000 hrs. at temperature and loading shown on derating curve.)  $\pm 5\%$  maximum group average.  $\pm 10\%$  maximum individual.

Terminal Strength.  $\pm 1\%$  maximum.

Solder.  $\pm 3\%$  maximum.

Acceleration, Shock, High Frequency Vibration.  $\pm 2\%$  maximum.

All tests performed as required in MIL-R-11 specification unless noted otherwise.

NOTE: Because of test inaccuracies common in measuring low resistance values, an allowance of 0.01 ohm should be added to the resistance change limits listed above.

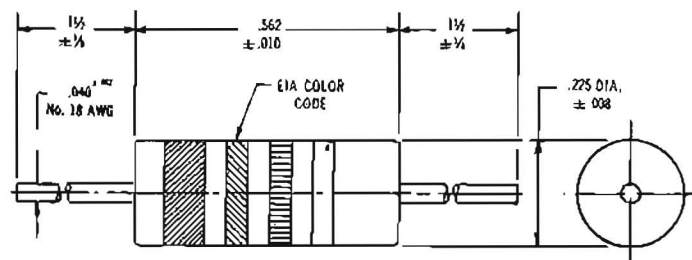



# RESISTOR KITS & ASSORTMENTS

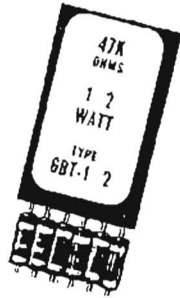

## HANDY-PAKS

The neatest, most compact resistor package available, and it's exclusive from IRC. Slimline plastic sleeve keeps leads straight and in place.

- Easier to identify—Type, resistance value and power rating on every Handy-Pak. Resistor color code is easily seen through the plastic.
- Handier to use—Opens at either end. Simply slide package out of plastic sleeve . . . withdraw the required number of resistors and slide the package into the sleeve.
- Quicker to find —Handy-Paks can be indexed by power rating and resistance. Resistors are always visible for inventory.

3 TYPES AVAILABLE—10% tolerance.

. . . ½ watt contains 6 GBT½ carbon composition resistors; 1 watt package contains 4 GBT1 resistors and the 2 watt Handy-Pak contains 3 SR2 resistors.



## RESIST-O-CADDY

Ideal for in-home servicing. Plastic pouch folds to 6¾" x 3⅞" x 1½" . . . fits easily in tube caddy or tool chest. Individual pockets keep Handy-Paks secure and orderly.

Accurate inventory is always visible. Resist-O-Caddy FREE with either of these two popular assortments:

### ASSORTMENT #41

120 GBT½ ½-watt resistors  
(10% tolerance)  
6 each of 20 values

ohms: 47 150 1,000 2,200 10K 27K 100K 270K

100 470 1,500 4,700 22K 47K 220K 470K

### ASSORTMENT #45

80 GBT1 1-watt resistors  
(10% tolerance)  
4 each of 20 values

1.0 meg 4.7 meg 2.2 meg 10 meg

## ASSORTMENT NO. 77

### SERVICE CONVENIENCE FROM IRC

This new BWI resistor assortment is a real time and work saver. Resistors are neatly mounted in a sturdy 6" x 12" molded plastic dispenser. They are removed easily, but do not fall out.



- Quick Identification—resistor value is printed on dispenser
- Instant Use—dispenser can be hung over workbench
- Fits easily in tube caddy or tool case
- Keeps leads straight for easier handling

### 38 LOW RANGE RESISTORS

Balanced assortment of miniature wirewounds. Two each of the following values:

.27	.56	1.2	2.7	5.6
.33	.68	1.5	3.3	6.8
.39	.82	1.8	3.9	8.2
.47	1.0	2.2	4.7	

### ONE RESISTOR FILLS THREE REQUIREMENTS

IRC's Type BWII is rated at 2 watts. Body size is the same as a standard 1 watt composition unit . . . small enough for ½ and 1 watt needs. This reduces resistor inventory and provides you with a four-time safety factor. Handles 2 watts at 70°C, 1 watt at 115°C and ½ watt at 137°C. These unique miniature resistors are direct replacements for composition units with the advantages of wirewound stability and low noise.

# RESISTOR KITS & ASSORTMENTS



**RESIST-O-CHEST.** A convenient, sturdy file of Handy-Paks in 6 popular assortments. Metal separators keep Handy-Paks in order at your fingertips. Reference data on inside of lid. Supplied FREE with any of these 5 fast-moving assortments.

### ASSORTMENT #42

204 GBT 1/2-watt resistors (10% tolerance)  
6 each of 34 values

ohms:	47	470	2,700	8,200	27K	56K	220K	1.0 meg	4.7 meg
	100	1,000	3,300	10K	33K	68K	270K	1.5 meg	10 meg
	150	1,500	4,700	15K	39K	100K	330K	2.2 meg	—
	220	2,200	6,800	22K	47K	150K	470K	3.3 meg	—

### ASSORTMENT #46

136 GBT 1-watt resistors (10% tolerance)  
4 each of 34 values

ohms:	47	470	2,700	8,200	27K	56K	220K	1.0 meg	4.7 meg
	100	1,000	3,300	10K	33K	68K	270K	1.5 meg	10 meg
	150	1,500	4,700	15K	39K	100K	330K	2.2 meg	—
	220	2,200	6,800	22K	47K	150K	470K	3.3 meg	—

### ASSORTMENT #43

462 GBT 1/2-watt resistors (10% tolerance)  
6 each of 77 values

### ASSORTMENT #47

308 GBT 1-watt resistors (10% tolerance)  
4 each of 77 values

### ASSORTMENT #48A

102 SR2 2-watt resistors (10% tolerance), 3 each of 34 values

ohms:	47	470	2,700	8,200	27K	56K	220K	1.0 meg	4.7 meg
	100	1,000	3,300	10K	33K	68K	270K	1.5 meg	10 meg
	150	1,500	4,700	15K	39K	100K	330K	2.2 meg	—
	220	2,200	6,800	22K	47K	150K	470K	3.3 meg	—

**RESIST-O-CABINET.** A practical way to give any shop a professional appearance. Sturdy metal Resist-O-Cabinets are FREE with any of four balanced assortments. Designed for stacking, and for tidy stocks of many small parts. Resist-O-Cabinets have four non-spill drawers and 28 compartments. Overall size is 5 3/4" x 5 1/2" x 10 3/4". Blue and silver finish.



1/2 WATT ASSORTMENT #4A 150 GBT 1/2-Watt Resistors		1 WATT ASSORTMENT #5A 125 GBT 1-Watt Resistors		2 WATT ASSORTMENT #3A 120 BWH and SR2 2-Watt Resistors		COMB. ASSORTMENT #6A 139 Insulated Resistors and Type DCF Precision Film Resistors				
QUANTITY	RANGE	QUANTITY	RANGE	QUANTITY	RANGE	RANGE	1/2 Watt	1 Watt	2 Watt	DCF
3	47 ohms	3	47 ohms	2	4.7 ohms	47 ohms	2	1	1	—
4	100 ohms	3	100 ohms	2	10 ohms	100 ohms	2	1	1	—
3	220 ohms	3	150 ohms	1	15 ohms	150 ohms	2	1	—	—
3	270 ohms	3	220 ohms	2	22 ohms	220 ohms	2	1	—	—
4	470 ohms	3	270 ohms	1	27 ohms	270 ohms	2	1	—	—
8	1,000 ohms	3	470 ohms	1	33 ohms	470 ohms	2	1	1	—
4	1,500 ohms	7	1,000 ohms	1	39 ohms	1,000 ohms	4	4	—	1
4	2,200 ohms	3	1,500 ohms	3	47 ohms	1,500 ohms	2	1	—	—
4	2,700 ohms	5	2,200 ohms	2	68 ohms	2,200 ohms	2	1	—	—
5	3,300 ohms	3	2,700 ohms	3	82 ohms	2,700 ohms	2	1	—	—
7	4,700 ohms	3	3,300 ohms	4	100 ohms	3,300 ohms	2	2	—	—
7	10K ohms	5	4,700 ohms	3	150 ohms	4,700 ohms	3	1	1	—
5	22K ohms	7	10K ohms	3	220 ohms	10K ohms	3	4	1	1
5	27K ohms	3	15K ohms	3	270 ohms	15K ohms	2	2	—	—
5	33K ohms	5	22K ohms	4	330 ohms	22K ohms	2	2	1	—
8	47K ohms	7	27K ohms	4	470 ohms	27K ohms	2	4	—	—
4	56K ohms	4	33K ohms	5	1,000 ohms	33K ohms	2	1	—	—
4	68K ohms	4	39K ohms	4	1,500 ohms	39K ohms	2	1	—	—
8	100K ohms	7	47K ohms	4	2,200 ohms	47K ohms	4	3	1	—
7	220K ohms	4	68K ohms	4	3,300 ohms	68K ohms	2	2	—	—
8	270K ohms	7	100K ohms	3	3,900 ohms	100K ohms	4	4	—	1
5	330K ohms	3	150K ohms	4	4,700 ohms	150K ohms	2	2	—	—
8	470K ohms	3	220K ohms	5	6,800 ohms	220K ohms	3	1	—	—
7	1.0 meg.	7	270K ohms	7	8,200 ohms	270K ohms	4	2	—	—
7	2.2 meg.	7	470K ohms	7	10K ohms	470K ohms	4	3	—	—
4	3.3 meg.	7	1.0 meg.	5	15K ohms	1.0 meg.	4	4	—	1
5	4.7 meg.	3	2.2 meg.	7	22K ohms	2.2 meg.	3	3	—	—
3	10.0 meg.	3	4.7 meg.	4	27K ohms	4.7 meg.	2	1	—	—
				7	47K ohms	5.0 meg.	—	—	—	1
				5	100K ohms					
				3	220K ohms					
				3	470K ohms					
				4	1.0 meg.					

**RESIST-O-GUIDES S-008B** Resistor Color Code Chart. New color, serrated edge wheels, up-dated information on IRC types, MIL styles and minimum and maximum values.





# TUBULAR POWER WIREWOUND RESISTORS



**RESISTEG COATED POWER RESISTORS** need no derating. They operate at full rated power even at high resistance values. Other features include heat resistant terminals for easy soldering, ceramic cores that withstand shock and are impervious to moisture, heavy windings that handle overloads without burnout, and standard size spring loaded push-in brackets for easy mounting on sizes of 25 watts and over.

IRC Tubular Power Wirewound Resistors are standard tubular construction with lugs and/or leads for use in general applications. They are used in DC and low frequency AC circuits where appreciable power must be dissipated:

- High voltage bleeder resistors in power supplies
- Voltage dropping resistors
- Voltage divider networks
- Bias supply resistor
- RC decoupling resistor
- Filament dropping resistor
- Load resistor
- Shunt resistor

## FIXED RESISTANCE TYPES

**TYPE 1A**—5-8 watts. Resisteg coating. Core Size: 1" long by 3/8" dia. Terminals: 13A. Tolerance: ±5%. No mounting hardware included. Standard package: 5.

Ohms					
1	20	200	750	2250	8000
1.5	25	225	800	2500	9000
2	30	250	900	3000	10K
3	35	300	1000	3500	12.5K
4	40	350	1100	4000	15K
5	50	400	1200	4500	17.5K*
7.5	75	450	1250	5000	20K*
10	100	500	1500	6000	22.5K*
12	125	600	1750	7000	25K*
15	150	700	2000	7500	

\* No. 1 Terminal

**TYPE 1 1/4A**—10-12 watts. Resisteg coating. Core Size: 1 1/4" long x 3/8" dia. Terminals: 13A. Tolerance: ±5%. No mounting hardware included. Standard package: 5.

Ohms					
1	30	350	1250	7000	17.5K
1.5	35	400	1500	7500	18K
2	40	450	1750	8000	20K
3	50	500	2000	8500	22.5K
4	75	600	2250	9000	25K
5	100	700	2500	10K	30K
7.5	125	750	3000	11K	35K
10	150	800	3500	12K	40K
12	200	900	4000	12.5K	45K
15	225	1000	4500	13.5K	50K
20	250	1100	5000	15K	
25	300	1200	6000	16K	

**TYPE 2C**—20 watts. Resisteg coating. Core size: 2" long x 3/8" dia. Terminals: 13A. Tolerance: ±5%. No mounting hardware included. Standard package: 5.

Ohms					
1	150	800	2750	10K	55K
2	200	900	3000	12.5K	60K
3	250	1000	3500	15K	65K
4	300	1200	4000	20K	70K
5	350	1250	4500	25K	75K
10	400	1500	5000	30K	80K
25	500	1750	6000	35K	85K*
50	650	2000	7000	40K	90K*
75	700	2250	7500	45K	95K*
100	750	2500	8000	50K	100K*
			9000		

\* No. 1 Terminal.

**TYPE 2D**—25 watts. Resisteg coating. Core size: 2" long x 3/8" dia. Terminals: 12A. Tolerance: ±5%. Mounting hardware included: Z-1 brackets. Standard package 1.

Ohms					
1	25	500	3000	12K	50K
2	50	750	3500	15K	60K
3	75	800	4000	20K	70K
4	100	1000	5000	25K	80K
5	150	1500	6000	30K	100K
10	200	2000	7500	35K	
15	250	2500	10K	40K	

**TYPE 4D**—50 watts. Resisteg coating. Core size: 4" long x 3/8" dia. Terminals: 12A. Tolerance: ±5%. Mounting hardware included: Z-1 bracket. Standard package: 1.

Ohms					
1	50	750	4000	20K	150K
2	75	800	5000	25K	175K
3	100	1000	7500	35K	200K
4	150	1500	8000	50K	250K
5	200	2000	10K	75K	
10	250	2500	12K	100K	
25	500	3000	15K	125K	

**TYPE 6 1/2E**—100 watts. Resisteg coating. Core size: 6 1/2" long x 3/4" dia. Terminals: 12A. Tolerance: ±5%. Mounting hardware included: Z-2 bracket. Standard package: 1.

Ohms					
1	25	250	2500	20K	75K
2	50	500	3000	25K	100K
3	75	750	5000	30K	
4	100	1000	7500	40K	
5	125	1500	10K	50K	
10	150	2000	15K	60K	

**TYPE 8 1/2H**—150-175 watts. Resisteg coating. Core size: 8 1/2" long x 1 1/8" dia. Terminals: 4A. Tolerance: ±5%. Mounting hardware included: Z-3 brackets. Standard package: 1.

Ohms					
1	25	250	2500	20K	75K
2	50	500	3000	25K	100K
3	75	750	5000	30K	
4	100	1000	7500	40K	
5	125	1500	10K	50K	
10	150	2000	15K	60K	

**TYPE 10 1/2H**—200-225 watts. Resisteg coating. Core size: 10 1/2" long x 1 1/8" dia. Terminals: 4A. Tolerance: ±5%. Mounting hardware included: Z-3 brackets. Standard package: 1.

Ohms					
1	25	250	2500	20K	75K
2	50	500	3000	25K	100K
3	75	750	5000	30K	
4	100	1000	7500	40K	
5	125	1500	10K	50K	
10	150	2000	15K	60K	

# ADJUSTABLE & MILITARY POWER RESISTORS



## ADJUSTABLE RESISTANCE TYPES

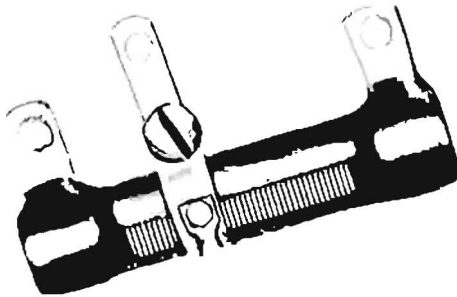

IRC Adjustable Power Wirewound Resistors are standard resistors with a track of exposed wire to allow for the adjustable feature. The track or slot is made by masking a section of the winding before coating, and then removing the mask after the coating has cured. No wire brushing, which could damage the resistance wire, is used.

The IRC adjustable feature provides the ideal solution to odd resistance values and to handling a variety of line voltages. One or more adjustable lugs may be used for voltage divided applications.

**TYPE 134AA**—10-12 watts. Core size: 1 3/4" long x 3/8" dia. Terminals: 12A. One adjustable band. Type A. Tolerance: ±10%. Standard package: 1. Mounting hardware included: Z-0 brackets.

Ohms	1	2	250	800	3000	7500
1	20	250	800	3000	7500	
2	25	300	1000	3500	8000	
3	50	350	1250	4000	8500	
5	75	400	1500	4500	9000	
7.5	100	500	2000	5000	10K	
10	150	600	2250	6000		
15	200	750	2500	7000		

**TYPE 2DA**—25 watts. Core size: 2" long x 3/8" dia. Terminals: 12A. One adjustable band. Type X-2. Tolerance: ±10%. Mounting hardware included: Z-1 bracket. Standard package: 1.

Ohms	1	2	250	1250	4000	9000
1	20	250	1250	4000	9000	
2	25	300	1500	4500	10K	
3	50	400	2000	5000	12K	
5	75	500	2250	6000	15K	
7.5	100	750	2500	7000	20K	
10	150	800	3000	7500	25K	
15	200	1000	3500	8000		

**TYPE 4DA**—50 watts. Core size: 4" long x 3/8" dia. Terminals: 12A. One adjustable band. Tolerance: ±10%. Mounting hardware included: Z-2 brackets. Standard package: 1.

Ohms	1	2	250	1250	4000	9000
1	75	750	3000	7500	25K	
2	100	800	3500	8000	30K	
3	150	1000	4000	9000	40K	
4	200	1250	4500	10K	50K	
5	250	1500	5000	12K	60K	
10	300	2000	6000	15K	80K	
25	400	2250	7000	20K	100K	
50	500	2500				

**TYPE 5EA**—75 watts. Core size: 5" long x 3/8" dia. Terminals: 12A. One adjustable band. Tolerance: ±10%. Mounting hardware included: Z-2 brackets. Standard package: 1.

Ohms	1	2	250	1250	4000	9000
1	5	100	1500	15K	40K	
2	10	250	2500	20K	50K	
3	25	500	5000	25K	75K	
4	50	1000	10K	30K	100K	

**TYPE 6 1/2 EA**—100 watts. Core size: 6 1/2" long x 3/4" dia. Terminals: 12A. One adjustable band. Tolerance: ±10%. Mounting hardware included: Z-2 brackets. Standard package: 1.

Ohms	1	2	250	1250	4000	9000
1	5	100	1500	15K	40K	
2	10	250	2500	20K	50K	
3	25	500	5000	25K	75K	
4	50	1000	10K	30K	100K	

**TYPE 8 1/2 HA**—160-175 watts. Core size: 8 1/2" long x 1 1/8" dia. Terminals: 4A. One adjustable band. Tolerance: ±10%. Mounting hardware included: Z-3 brackets. Standard package: 1.

Ohms	1	2	250	1250	4000	9000
1	5	100	1500	15K	40K	
2	10	250	2500	20K	50K	
3	25	500	5000	25K	75K	
4	50	1000	10K	30K	100K	

**TYPE 10 1/2 HA**—200-225 watts. Core size: 10 1/2" long x 1 1/8" dia. Terminals: 4A. One adjustable band. Tolerance: ±10%. Mounting hardware included: Z-3 brackets. Standard package: 1.

Ohms	1	2	250	1250	4000	9000
1	5	100	1500	15K	40K	
2	10	250	2500	20K	50K	
3	25	500	5000	25K	75K	
4	50	1000	10K	30K	100K	

## TERMINAL AND BRACKET TYPES

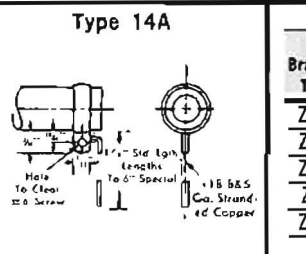
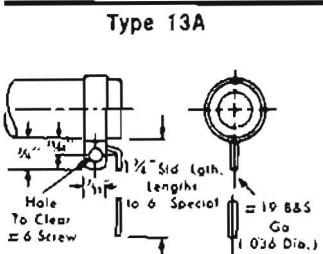
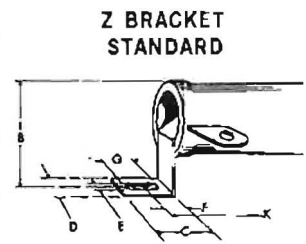
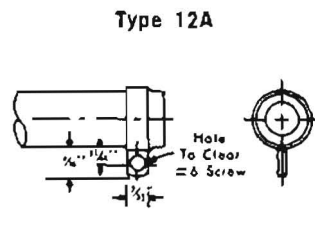
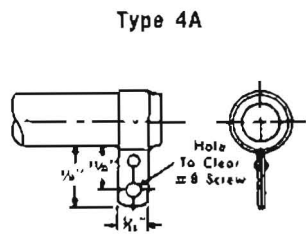
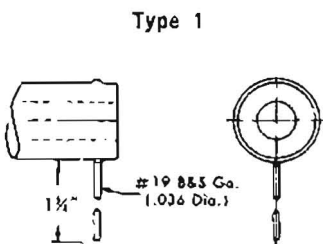

Bracket Type	Use with Resistor O.D.	Type	DIMENSIONS							K
			A	B	C	D	E	F	G	
Z-0	3/16	A	—	1 1/32	1/2	3/16	.173	1 1/4	.266	Core Lgth. + 1 1/2
Z-1	3/16	D	—	1 1/4	3/16	3/16	.173	3/8	1 1/4	" " + 3/8
Z-2	3/4	E	—	1 1/4	3/8	3/8	.173	1 1/2	2 1/4	" " + 1 1/16
Z-3	1 1/8	H	—	2 1/16	1 1/16	1/2	3/8	1 1/2	1/4	" " + 1 1/16
Z-4	3/16	C	—	3/8	3/16	3/32	3/16	1/4	3/16	" " + 1/2





# POWER & FUSE RESISTORS

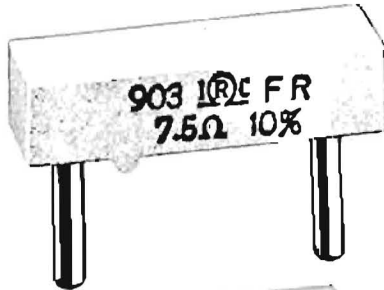

## FUSE RESISTORS

This special resistor functions as a resistor under normal conditions, and as a fuse under overload conditions. It is used extensively as a surge-limiting resistor in voltage doubler circuits of TV receivers. Installation of an IRC Type FR fuse resistor in a TV set will prevent overloading of more valuable components and possible fire due to a short circuit. The compact, modern design of IRC fuse resistor measures only  $1\frac{1}{4}'' \times \frac{1}{2}'' \times \frac{3}{8}''$ . This unit is completely insulated in a rectangular ceramic case, and equipped with plug-in terminals.

FR5.0\*—5 ohms  
FR5.6—5.6 ohms  
FR7.5—7.5 ohms

\*suitable for 4.7Ω fuse for resistor applications

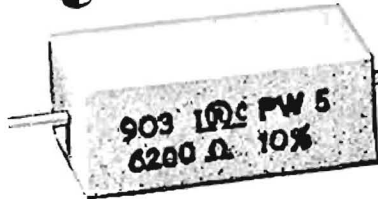

## AXIAL LEAD POWER WIRE WOUND RESISTORS TYPES PW5 PW10 STANDARD STOCK VALUES

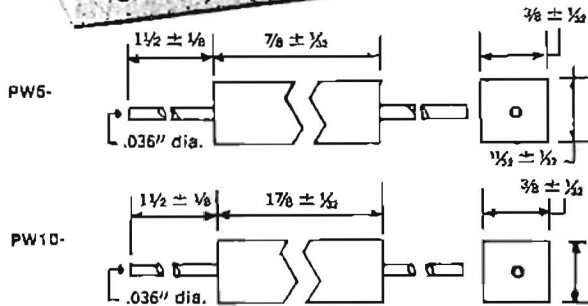

PW5				PW10			
Ohms:				Ohms:			
.15	7.5	300	2000	1	120	1000	6000
.22	10	350	2250	2	125	1200	7000
.27	15	400	2500	3	150	1250	7500
.33	20	500	3000	4	200	1500	8000
.47	25	600	3300	5	250	1750	8200
.51	30	700	3500	7.5	300	2000	8500
.56	40	750	3900	10	350	2250	9000
.68	50	800	4000	15	400	2500	10,000
.82	75	820	4500	20	500	3000	12,000
1	100	900	5000	25	600	3300	12,500
2	120	1000	6000	30	700	3500	15,000
3	125	1200		40	750	3900	20,000
4	150	1250		50	800	4000	25,000
5	200	1500		75	820	4500	
5.6	250	1750		100	900	5000	

These popular axial lead power resistors are the industry favorites for 5 and 10 watt applications. The compact shape fits among other components more easily. The axial lead design speeds installation. And, the superior solderability of the terminals assures sound connections every time. A precisely wound element is sealed in a ceramic case—fully protected and insulated. Conservative rating permits continuous operation at full power. Resistance, wattage

and tolerance are permanently marked on resistor body. Standard tolerance is 10%.

*Popular Assortments* of PW5 and PW10 resistors are available for handy bench stocks. Values are selected on the basis of usage. Resistors are mounted on plastic covered cards with hole for hanging.

Assortment #PW5x10 10 best selling PW5 resistors  
Assortment #PW5x20 20 best selling PW5 resistors  
Assortment 20A 20 best selling PW10 resistors

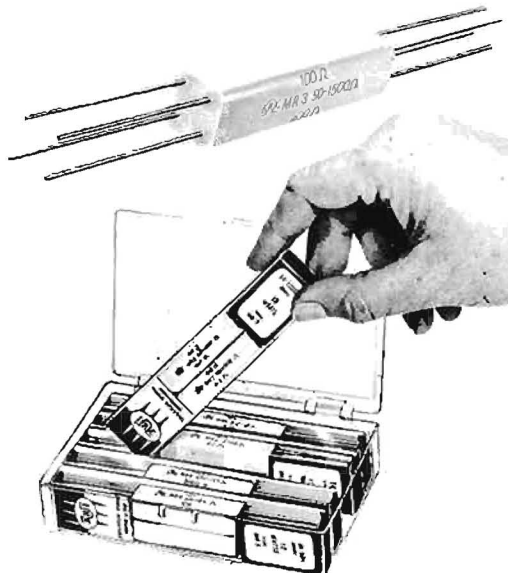

## MULTI-RANGE POWER RESISTORS

Up to 47 values from a single resistor. 5 multi-range resistors give complete 10 watt coverage . . . 200 values from  $\frac{1}{2}$  to 50,000 ohms. No delays for a particular value, and you don't tie up inventory with odd values. Ideal for in-home servicing and weekend shop work.

Four-wire wound elements are sealed in a statite housing. It's simple to solder a basic interconnection for the required value, and cut off unused terminals. Connection diagrams included.

### 5 TYPES COVER 200 VALUES

TYPE MR1. 0.5 through 15 ohms. 1, 2, 4, 8 ohm elements. 10 watts. 47 values.  
TYPE MR2. 5 through 150 ohms. 10, 20, 40, 80 ohm elements. 10 watts. 47 values.

TYPE MR3. 50 through 1,500 ohms. 100, 200, 400, 800 ohm elements. 10 watts. 47 values.

TYPE MR4. 500 through 15K ohms. 1K, 2K, 4K, 8K ohm elements. 10 watts. 47 values.

TYPE MR5. 3K through 50K ohms. 10K, 10K, 15K, 15K ohm elements. 10 watts. 12 values.

### MULTI-RANGE KIT #55

Complete 10 watt power resistor coverage that fits in the palm of your hand. Rigid clear plastic case holds 5 Handy-Paks, 2 of each type MR resistor. With these 10 versatile resistors you have finger-tip coverage of 200 values from  $\frac{1}{2}$  to 50,000 ohms. Fits easily in tool case or tube caddy.

# DUAL DIODES

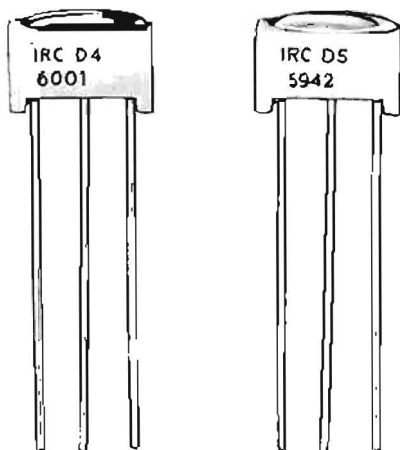

**DIODES.** Universal selenium dual diodes for horizontal phase detectors and remote control in TV receivers. Also used in radio control devices for model planes, and other circuits. Available in four basic types.

The small size, economy, ease of installation and reliable construction of the IRC dual selenium diodes make them ideal for many low-voltage, low-frequency applications. To suit them to various circuits, these dual diodes have either common-anode, common-cathode, or series form of internal connection. The cells in each unit are matched to assure electrical balance.

Alloy-plated leads facilitate soldering. No clamp or other mounting device is needed, since the three leads readily support this flyweight unit.

### Designed for Long Life

Construction features include an integral heatsink and a "floating" spring that gives proper pre-load over the full operating temperature range. No paper, laminates or other material that might absorb moisture are used. Moisture-excluding materials cushion the active elements and isolate them from encapsulant.

### Electrically Balanced and Noise Free

IRC processes each selenium cell to give it a smooth, uncontaminated surface and periphery with no fractures. This technique insures uniform current density over the entire cell area and prevents noisy, unreliable operation.

To indicate polarity, one corner of the case has a diagonal cutoff. This assures correct orientation of units in automated assembly, and allows use of both sight and touch to get proper polarity at manual assembly and inspection.

## TV DUAL DIODES

### REPLACEMENT INFORMATION

#### TYPE D4 COMMON CATHODE

Manufacturer	Part No.	Manufacturer	Part No.
Admiral	93B-6, 9 93C26-7, 9	Muntz	SR004
Airline	66X21	Olympic	RF5465-1 RF5794-1
Coronado	296V004H01	Packard Bell	72053
Curtis Mathes	66X21, 25 9LR2-S 21A2	Philco	34-8034 34-8037-1, 2, 3 109328, 109474 1107832-7, 9, 10, 11
Dominion	702-810	RCA	9LR2
Electrohome	14-501-01	Satchell-Carlson	86-9-1
Emerson	817062 817074 817126	Silvertone	86-18-1 624-0037 051 109328
Federal I.T.T.	K1615 P15	Sylvania	624-0006 624-0007 13-85943-1, 2, 3
GE	6GC1 ET16X10 K115J510-1, 2 K117J460-1, 2 WT16X7	Tel-Rad	TRC-P4
Hallcrafters	27C226 027-300-226	Travler	SR6 SR13 SR20
Hoffman	10031 744002 744006 DD04	Truetone	66X21, 25
International Rectifier	530093-1 48C751656 48K741255	Wells-Gardner	66X21, 25
Magnavox		Westinghouse	296V004H01
Motorola		Workman	SD4
		Zenith	103-20 103-32

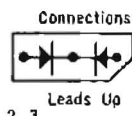

#### TYPE D5 SERIES CONNECTED

Manufacturer	Part No.	Manufacturer	Part No.
Admiral	93A5-2 93B5-3, 4, 5, 6	Olympic	RF5794 72030
Airline	SR15	Packard Bell	B-45-110 B-48-110 386-4-1A
Citizenship Radio	34-8037	Silvertone	D76 86-3-1
Coronado	SR15	Sonora	SR15
Dominion	14-503-01	Sylvania	13-93889
Electrohome		Tel-Rad	TRC-55
Emerson	817062 817962 K1616 P16	Travler	SR10 SR15
Federal I.T.T.	6GD1 K118J956-1 WT16X9	Truetone	SR10 SR15
GE	DD05	Webcor	35P113 G9P17741 5P124-1 SD5 633977
International Rectifier	5336045-1, 2, 3	Workman	
Magnavox	48B742698 48K741752 48K742698 48K754153 65K744238	Zenith	
Motorola			

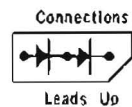

#### TYPE D6 COMMON ANODE

Manufacturer	Part No.
Federal I.T.T.	K1617 P17
GE	6GX1 118J966-2 WT16X8
International Rectifier	0006
Motorola	48K751724
Packard Bell	72038
RCA	107268
Workman	SD6

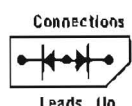

#### TYPE D7 SPECIAL MOTOROLA SIX CELL DIODE

Manufacturer	Part No.
International Rectifier	OD07
Motorola	48C65831A02

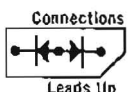



# PRECISION WIREWOUND RESISTORS

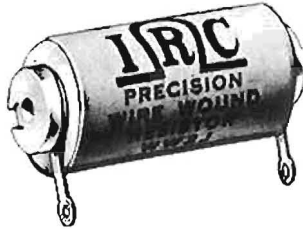

## WIREWOUND PRECISION RESISTORS.

For accuracy in critical applications, IRC Precision Wire Wound resistors are produced to exacting standards of reliability. IRC's winding technique prevents shorted turns or strains in the winding, and special insulation gives excellent protection from humidity. Positive electrical connections and easy soldering.

### RADIAL LUG TYPES

IRC TYPE NO	WW2J	WW3J	WW4J	WW5J	WW8J*	WW11J*
MIL-R-93A Style	RB19	RB16	RB17	RB18	RD15	RB16
Rating In Watts 65°C. Ambient	2	.50	1	1	.50	.50
Maximum Volts	2000	400	700	1000	250	500
No. of Sections	8	2	4	4	1	2
Maximum Resistance .0015 Diameter Wire	4.0 Meg.	0.3 Meg.	0.75 Meg.	1.7 Meg.	0.29 Meg.	0.4 Meg.
Maximum Resistance .0009 Diameter Wire	20.0 Meg.	1.6 Meg.	4.0 Meg.	7.5 Meg.	1.5 Meg.	2.0 Meg.
Minimum Resistance (ohms)						
±0.05% Tolerance	25	25	25	25	25	25
±0.1% Tolerance	10	10	10	10	10	10
±0.25% Tolerance	5	5	5	5	5	5
±0.50% Tolerance	1	1	1	1	1	1
±1.0% Tolerance	0.1	0.1	0.1	0.1	0.5	0.1

### RADIAL LEAD TYPES

IRC TYPE NO.	WW3J*	WW4J*	WW8J*	WW10J	WW11J*	WW20J*	WW21J*	WW22J* (Center Tapped)	WW23J*	WW24J* (Center Tapped)
Rating in Watts 65°C. Ambient	.50	1	.50	.25	.50	.25	.25	.25†	.50	.50†
Maximum Volts	400	700	250	150	500	150	300	150†	300	400†
No. of Sections	2	4	1	1	2	1	2	2	2	4
Maximum Resistance .0015 Diameter Wire	0.3 Meg.	0.75 Meg.	0.29 Meg.	40K	0.4 Meg.	35K	70K	35K†	225K	350K†
Maximum Resistance .0009 Diameter Wire	1.6 Meg.	4.0 Meg.	1.5 Meg.	0.215 Meg.	2.0 Meg.	150K	500K	250K	1.5 Meg.	1.5 Meg.†
Minimum Resistance (ohms)										
±0.05% Tolerance	25	25	25	200	25	250	200	200†	25	25 †
±0.10% Tolerance	10	10	10	150	10	200	150	150†	10	10 †
±0.25% Tolerance	5	5	5	75	5	100	75	75†	5	5 †
±0.5% Tolerance	1	1	1	50	1	75	50	50†	1	1 †
±1.0% Tolerance	0.1	0.1	0.5	10	0.1	10	10	10†	0.5	0.1†

† signifies per tap section

\* Special manufacturing applies

### STANDARD STOCK TYPES AND VALUES

**TYPE WW2J with lugs—1% Tolerance**

600K Ohms	1.0 Megohm
750K Ohms	1.5 Megohms
900K Ohms	2.0 Megohms
	2.5 Megohms

**TYPE WW3J with lugs—1% Tolerance**

0.1 Ohm	1,500 Ohms	30K Ohms
0.2 Ohm	2,000 Ohms	35K Ohms
0.5 Ohm	2,500 Ohms	40K Ohms
1.0 Ohm	3,000 Ohms	50K Ohms
5 Ohms	3,500 Ohms	60K Ohms
10 Ohms	4,000 Ohms	75K Ohms
25 Ohms	5,000 Ohms	100K Ohms
50 Ohms	7,500 Ohms	125K Ohms
100 Ohms	10K Ohms	150K Ohms
200 Ohms	12.5K Ohms	175K Ohms
250 Ohms	15K Ohms	200K Ohms
300 Ohms	20K Ohms	225K Ohms
500 Ohms	22.5K Ohms	
1,000 Ohms	25K Ohms	

**TYPE WW4J with lugs—1% Tolerance**

0.1 Ohm	2,000 Ohms	40K Ohms
0.2 Ohm	2,500 Ohms	50K Ohms
0.5 Ohm	3,000 Ohms	60K Ohms
1.0 Ohm	3,500 Ohms	75K Ohms
5 Ohms	4,000 Ohms	100K Ohms
10 Ohms	5,000 Ohms	125K Ohms
25 Ohms	7,500 Ohms	150K Ohms
50 Ohms	10K Ohms	175K Ohms
100 Ohms	12.5K Ohms	200K Ohms
200 Ohms	15K Ohms	225K Ohms
250 Ohms	20K Ohms	250K Ohms
300 Ohms	22.5K Ohms	300K Ohms
500 Ohms	25K Ohms	400K Ohms
1,000 Ohms	30K Ohms	500K Ohms
1,500 Ohms	35K Ohms	

**TYPE WW10J with leads—1% Tolerance**

10 Ohms	2,000 Ohms	20K Ohms
25 Ohms	2,500 Ohms	25K Ohms
50 Ohms	3,000 Ohms	30K Ohms
100 Ohms	3,500 Ohms	40K Ohms
200 Ohms	4,000 Ohms	50K Ohms
250 Ohms	5,000 Ohms	60K Ohms
300 Ohms	7,500 Ohms	75K Ohms
500 Ohms	10K Ohms	100K Ohms
1,000 Ohms	12.5K Ohms	
1,500 Ohms	15K Ohms	

**TYPE WW5J with lugs—1% Tolerance**

600K Ohms	900K Ohms
750K Ohms	1.0 Megohm

**Special Resistance Tolerances**  
Standard tolerances ±1%. Other tolerances, subject to minimum values shown on specification charts, are available on special order for all WWJ types, as follows:

0.5%	0.25%	0.2%	0.1%	0.05%
------	-------	------	------	-------

# PRECISION DEPOSITED CARBON RESISTORS



**DEPOSITED CARBON PRECISIONS** are available in 1/2, 1 and 2 watt sizes. The wide range of values, 1% tolerance, economy, low voltage coefficient, excellent frequency characteristics, predictable temperature, high voltage rating, low noise level, and small size make IRC deposited carbon resistors ideal for application in advanced electronic equipment and critical TV circuits.



**MOLDED DEPOSITED CARBON RESISTORS** are designed for high reliability, stable performance, low voltage coefficient, low capacitive and inductive impedance in high frequency applications. In miniature 1/8, 1/4, and 1/2 watt sizes, plus 1 and 2 watt types.

Standard tolerance is 1%. (2% tolerance on high range units.) The housing gives complete protection, and offers better heat dissipating qualities. This results in improved load life and maximum moisture protection.

## MIL VALUES—TYPES DCC, DCF, DCH and MDC

One decade of standard values is as follows:

Ohms	Ohms	Ohms	Ohms	Ohms	Ohms	Ohms	Ohms	Ohms	Ohms	Ohms	Ohms
10.0	12.1	14.7	17.8	21.5	26.1	31.6	38.3	46.4	56.2	68.1	82.5
10.2	12.4	15.0	18.2	22.1	26.7	32.4	39.2	47.5	57.6	69.8	84.5
10.5	12.7	15.4	18.7	22.6	27.4	33.2	40.2	48.7	59.0	71.5	86.6
10.7	13.0	15.8	19.1	23.2	28.0	34.0	41.2	49.9	60.4	73.2	88.7
11.0	13.3	16.2	19.6	23.7	28.7	34.8	42.2	51.1	61.9	75.0	90.9
11.3	13.7	16.5	20.0	24.3	29.4	35.7	43.2	52.3	63.4	76.8	93.1
11.5	14.0	16.9	20.5	24.9	30.1	36.5	44.2	53.6	64.9	78.7	95.3
11.8	14.3	17.4	21.0	25.5	30.9	37.4	45.3	54.9	66.5	80.6	97.6

Higher standard values may be determined by multiplying by 10, 100, 1000, etc., up to maximum stated for type.

## SELECTION GUIDE

IRC Type	MIL		Power Watts		Resistance		Tolerance	Body Size	Temperature Coefficient PPM/°C	Lead Dia.
	Type	Char.			Min. Ohms	Max. Ohms				
	MIL-R-10509		@ 70°C	@ 125°C			0.5% 1.0% 2.0%			
DM	RN55	D	1/4		10	301K		—500	.250x.093	.025
MDA	RN60	B, D	1/8, 1/4	1/8	10	5 meg.		—500	.406x.130	.025
MDB	RN65	B, D	1/4, 1/2	1/4	10	5 meg.		—500	.594x.203	.025
MDC	RN70	B, D	1/2, 1	1/2	10	25 meg.		—500	.719x.216	.032
MDF	RN70	B	1		10	50 meg.		—500	1.105x.395	.032
MDH	RN80	B	2		15	100 meg.		—500	2.234x.395	.032
DCC	RN20	X	@ 40°C	@ 70°C	10	25 meg.		—500	.594x.156	.032
DCF	RN25	X	1	1/2	10	50 meg.	—500	.938x.297	.032	
DCH	RN30	X	2		15	100 meg.	—500	2.062x.297	.032	



# SNAPTROL

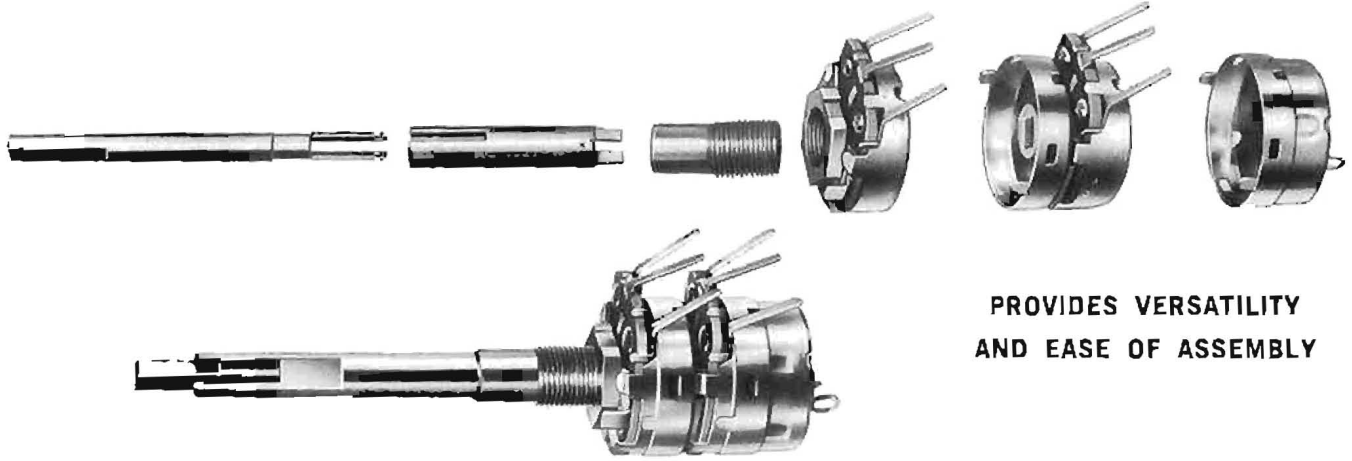

**PROVIDES VERSATILITY  
AND EASE OF ASSEMBLY**

**SNAPTROL.** Newest of three IRC replacement systems designed to provide servicing technicians with satisfactory replacements for comprehensive coverage of single controls, tandem dual controls, matched stereo controls and concentric dual controls for television, radio, auto sets and high fidelity equipment.

SNAPTROL provides a broad variety of basic, factory assembled control sections, shafts and switches which snap together to provide a wide selection of replacement controls. Literally, it is a "snap" to assemble nearly any standard or special control.

**SERIES 45 INDUSTRIAL CONTROLS.** With a variety of five basic control components, the Series 45 line permits quick assembly of 12,631,500 different control specifications. These include single, double, triple and quadruple section controls, with or without power switches, in all popular styles and ranges needed for industrial electronic equipment.

Series 45 components are completely compatible and interchangeable with SNAPTROL. Together, these two snap-together systems provide an almost unlimited means to furnish unusual and special controls for industrial applications.

**EASY TO USE.** Parts assemble into exact duplicate control in 15 to 30 seconds. Sections completely factory assembled. No shaft cutting or modification needed.

**GREATER VERSATILITY.** SNAPTROL provides new and unique designs which provide for better utility and adaptability of component parts:

1—Interchangeable Control Mountings.  $\frac{3}{8}$ ",  $\frac{7}{16}$ " and  $\frac{1}{2}$ " diameter bushings of varying lengths and bores, quickly thread into front control sections. Accommodates thick panel requirements without extra bushing or adjuster. Specially designed tab mounting plates or printed circuit brackets easily attached in place of bushings. This exclusive new design feature reduces the number of front sections needed and extends their use in a greater variety of replacement needs.

2—Printed Circuit Terminals. All carbon control sections are equipped with terminals that will handle both conventional and printed circuit wiring. This original CTS-IRC terminal design doubles the adaptability of control sections.

3—Rotary or Pull-Push Power Switches. Either type of power switch snaps onto either carbon Front or Rear Sections. Another exclusive CTS-IRC design feature which very considerably increases the utility of control components.

4—Uniform Diameter Rear Section Shafts. New design of rear section (inner) shafts provide uniform diameter — permits use of heavy-walled front section (outer) shaft contributing better concentric shaft operation and superior knob retention. Simple compression type adapter fits rear section shaft to knobs normally requiring larger diameter. No drilling or modification of knobs needed. Shafts are flatted or slotted as required - - no shaft insert or line needed! This new design reduces the number of exact length shafts required for broad replacement coverage.

5—Front Sections Serve for Single Controls. Without modification or adapters, all SNAPTROL front sections may be used for single control replacements. Provides practical use of single front section for special bushings, tab mountings, printed circuits, special shaft needs and a variety of power switches. No other section-type control system provides such broad versatility.

**FEWER COMPONENT PARTS.** Because of the realistic design features provided, SNAPTROL requires far fewer items of components than any other section-type exact duplicate control system which offers so broad a replacement coverage. (Over 1700 exact duplicate concentric dual controls and many thousands of single controls.)

**BEST SELLING CONTROLS.** SNAPTROL is a special replacement design of the world's most frequently specified and most widely sold CTS Series 45 control. Over 300,000,000 in current use — a strong testimony to the quality and performance of these outstanding controls.

# SNAPTROL



## SNAPTROL CARBON AND WIREWOUND FRONT SECTIONS

Type CF Carbon Front Sections and Type WF Wirewound Front Sections are factory-assembled controls supplied without control mounting, shaft or dust cover. Bushing, tab mounting plate or printed circuit bracket thread into front section as required. Carbon or wirewound rear sections snap onto either style front section for concentric or tandem dual controls. A variety of single or concentric outer shafts snap into front sections. Either rotary or pull-push switches will snap onto CF Front Sections. WF Front Sections will not operate switches. Printed Circuit Terminals are employed



Type CF—no tap



Type CF—one tap



Type CF two taps



Type WF

on CF sections while standard hole-type terminals are supplied on WF sections. Diameter of either front section is  $\frac{3}{16}$ ". Wattage rating: CF Sections —  $\frac{1}{2}$  watt, WF Sections — 5 watts (*linear tapered sections*).

### LISTING BY STOCK NUMBER

STOCK NO.	OHMS	TAPS	TAPER*	STOCK NO.	OHMS	TAPS	TAPER*	STOCK NO.	OHMS	TAPS	TAPER*
CF1	100	—	1	CF31	2000	—	4	CF61	10 K	—	3
CF2	250	—	1	CF32	2500	—	4	CF62	20 K	—	3
CF3	300	—	1	CF33	3000	—	4	CF63	50 K	—	2
CF4	500	—	1	CF34	5000	—	4	CF64	750 K	—	4
CF5	750	—	1	CF35	10 K	—	4	CF65	1.0 Meg	—	4
CF6	1000	—	1	CF36	750	—	5	CF66	1.5 Meg	—	3
CF7	1500	—	2	CF37	1000	—	5	CF67TT	2.0 Meg	500 K & 1.0 M	49
CF8	5000	—	2	CF38	5.0 Meg	—	6	CF68TT	2.0 Meg	300 K & 600 K	50
CF9	10 K	—	2	CF39	5.0 Meg**	—	7	CF69	7.5 Meg	—	2
CF10	15 K	—	2	CF40T	750	250	8	CF70	10 Meg	—	2
CF11	25 K	—	2	CF41T	3000	150	9	WF1	200	—	U
CF12	50 K	—	2	CF42T	15 K	10 K	10	WF2	750	—	U
CF13	100 K	—	2	CF43T	500 K	125 K	11	WF3	1000	—	U
CF14	200 K	—	2	CF44T	1.0 Meg	250 K	11	WF4	1500	—	U
CF15	250 K	—	2	CF45T	2.0 Meg	500 K	11	WF5	2000	—	U
CF16	500 K	—	2	CF46T	500 K	250 K	12	WF6	2500	—	U
CF17	1.0 Meg	—	2	CF47T	1.0 Meg	500 K	12	WF7	3000	—	U
CF18	1.5 Meg	—	2	CF48T	500	60	14	WF8	5000	—	U
CF19	2.0 Meg	—	2	CF49T	30 K	10 K	8	WF9	10 K	—	U
CF20	2.5 Meg	—	2	CF50	500	—	5	WF10	15 K	—	U
CF21	3.0 Meg	—	2	CF51	200 K	—	4	WF11	750	—	R
CF22	5.0 Meg	—	2	CF52	100 K	—	3	WF12	2500	—	R
CF23	250 K	—	3	CF53	1200	—	4	WF13	3000	—	R
CF24	350 K	—	3	CF54	75 K	—	2	WF14	5000	—	R
CF25	500 K	—	3	CF55	2.0 Meg	—	4	WF15T	750	250	S
CF26	1.0 Meg	—	3	CF56	5.0 Meg	—	4	WF16	10	—	S
CF27	2.0 Meg	—	3	CF57T	2.0 Meg	1.0 Meg	12	WF17	20	—	U
CF28	3.0 Meg	—	3	CF58T	3.0 Meg	1.5 Meg	12	WF18	50	—	U
CF29	5.0 Meg	—	3	CF59	3000	—	2	WF19	100	—	U
CF30	1500	—	4	CF60	5000	—	3	WF20	500	—	U

\* See Taper explanation chart, page 28

\*\* Element open at center

### LISTING BY RESISTANCE VALUE

OHMS	TAPS	TAPER*	STOCK NO.	OHMS	TAPS	TAPER*	STOCK NO.	OHMS	TAPS	TAPER*	STOCK NO.
100	—	1	CF1	50 K	—	2	CF12	3.0 Meg	—	2	CF21
250	—	1	CF2	50 K	—	3	CF63	3.0 Meg	—	3	CF28
300	—	1	CF3	75 K	—	2	CF54	3.0 Meg	1.5 Meg	12	CF58T
500	—	1	CF4	100 K	—	2	CF13	5.0 Meg	—	2	CF22
500	—	5	CF50	100 K	—	3	CF52	5.0 Meg	—	3	CF29
500	60	14	CF48T	200 K	—	4	CF51	5.0 Meg	—	4	CF56
750	—	1	CF5	200 K	—	2	CF14	5.0 Meg	—	6	CF38
750	—	5	CF36	250 K	—	2	CF15	5.0 Meg*	—	7	CF39
750	250	8	CF40T	250 K	—	3	CF23	7.5 Meg	—	2	CF69
1000	—	1	CF6	350 K	—	3	CF24	10 Meg	—	2	CF70
1000	—	5	CF37	500 K	—	2	CF16	10	—	U	WF16
1200	—	4	CF53	500 K	—	3	CF25	20	—	U	WF17
1500	—	2	CF7	500 K	125 K	11	CF43T	50	—	U	WF18
1500	—	4	CF30	500 K	250 K	12	CF46T	100	—	U	WF19
2000	—	4	CF31	750 K	—	2	CF64	200	—	U	WF1
2500	—	4	CF32	1.0 Meg	—	2	CF17	500	—	U	WF20
3000	—	2	CF59	1.0 Meg	—	3	CF26	750	—	U	WF11
3000	—	4	CF33	1.0 Meg	—	4	CF65	750	250	S	WF15T
3000	150	9	CF41T	1.0 Meg	250 K	11	CF44T	750	—	U	WF2
5000	—	2	CF8	1.0 Meg	500 K	12	CF47T	1000	—	U	WF3
5000	—	3	CF60	1.5 Meg	—	2	CF18	1500	—	U	WF4
5000	—	4	CF34	1.5 Meg	—	3	CF66	2000	—	U	WF5
10 K	—	2	CF9	2.0 Meg	—	2	CF19	2500	—	U	WF12
10 K	—	3	CF61	2.0 Meg	—	3	CF27	2500	—	R	WF6
10 K	—	4	CF35	2.0 Meg	—	4	CF55	3000	—	U	WF13
15 K	—	2	CF10	2.0 Meg	500 K	11	CF45T	3000	—	U	WF7
15 K	10 K	10	CF42T	2.0 Meg	1.0 Meg	12	CF37T	5000	—	U	WF14
20 K	—	2	CF62	2.0 Meg	500 K & 1.0 M	49	CF67TT	5000	—	U	WF8
25 K	—	2	CF11	2.0 Meg	300 K & 600 K	50	CF68TT	10 K	—	U	WF9
30 K	10 K	8	CF49T	2.5 Meg	—	2	CF20	15 K	—	U	WF10

\* See Taper explanation chart, page 28

\*\* Element open at center



# SNAPTROL

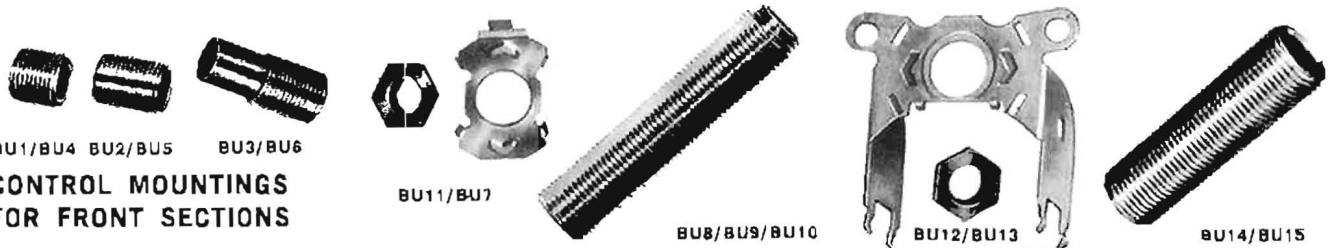

## CONTROL MOUNTINGS FOR FRONT SECTIONS

A variety of control mountings permit the use of SNAPTROL Front Sections for many different replacement controls. Bushings of varying diameters and inside bores thread into front sections. Tab mounting plates and printed circuit brackets attach to front section with special male nut supplied with each.

This exclusive design feature of selectable control mountings actually reduces inventory investment for distributors and servicing technicians. For a specific resistance value and taper, only one SNAPTROL Front Section is needed—in contrast to other systems where an additional front section is needed for each different control mounting.

Stock No.	Description	Stock No.	Description
BU1	Bushing $\frac{3}{8}$ "—32 x $\frac{1}{4}$ " FMS— for single controls	BU9	Bushing $\frac{1}{4}$ "—28 x $2\frac{1}{4}$ " FMS— for concentric controls. Double flat.
BU2	Bushing $\frac{3}{8}$ "—32 x $\frac{3}{8}$ " FMS— for single controls	BU10	Bushing $\frac{1}{2}$ "—28 x $2\frac{1}{4}$ " FMS— for concentric controls. Single flat.
BU3	Bushing $\frac{3}{8}$ "—32 x $\frac{1}{2}$ " FMS— for single controls	BU11	Tab mounting with nut— for single controls
BU4	Bushing $\frac{3}{8}$ "—32 x $\frac{1}{4}$ " FMS— for concentric controls	BU12	Printed circuit bracket with nut— for single controls
BU5	Bushing $\frac{3}{8}$ "—32 x $\frac{3}{8}$ " FMS— for concentric controls	BU13	Printed circuit bracket with nut— for concentric controls
BU6	Bushing $\frac{3}{8}$ "—32 x $\frac{1}{4}$ " FMS— for concentric controls	BU14	Bushing $\frac{3}{8}$ "—32 x $1\frac{3}{4}$ " FMS— for single controls
BU7	Tab mounting with nut— for concentric controls	BU15	Bushing $\frac{3}{8}$ "—32 x 2" FMS— for concentric dual controls.
BU8	Bushing $\frac{1}{4}$ "—28 x $1\frac{1}{8}$ " FMS— for concentric controls		

## CARBON & WIREWOUND REAR SECTIONS

Type CR Carbon Rear Sections and Type WR Wirewound Rear Sections snap onto SNAPTROL Front Sections for use as either concentric dual or tandem dual controls. Rotary or pull-push power switches snap onto CR sections. WR sections do not accept switches. Rear or inner concentric shafts snap into either type of rear sections for concentric dual operation. SS7A Intersection Insert provides tandem dual operation. Additional tandem sections may be snapped on by use of SS13 Multisection Couplers.



LISTING BY STOCK NUMBER			
STOCK NO.	OHMS	TAPS	TAPER*
CR1	100	—	1
CR2	1000	—	1
CR3	2000	—	2
CR4	5000	—	2
CR5	10 K	—	2
CR6	25 K	—	2
CR7	50 K	—	2
CR8	100 K	—	2
CR9	200 K	—	2
CR10	250 K	—	2
CR11	500 K	—	2
CR12	1.0 Meg.	—	2
CR13	1.5 Meg.	—	2
CR14	2.0 Meg.	—	2
CR15	2.5 Meg.	—	2
CR16	3.0 Meg.	—	2
CR17	5.0 Meg.	—	2
CR18	250 K	—	3
CR19	350 K	—	3
CR20	500 K	—	3
CR21	1.0 Meg.	—	3
CR22	2.0 Meg.	—	3
CR23	3.0 Meg.	—	3
CR24	5.0 Meg.	—	3
CR25	2000	—	4
CR26	10 K	—	4
CR27	750	—	5
CR28	1000	—	5
CR29T	250 K	60 K	11
CR30T	350 K	75 K	11
CR31T	500 K	125 K	11
CR32T	1.0 Meg.	250 K	11
CR33T	2.0 Meg.	500 K	11
CR34T	250 K	125 K	12
CR35T	500 K	250 K	12
CR36T	1.0 Meg.	500 K	12
CR37T	2.0 Meg.	1.0 Meg.	12
CR38T	3.0 Meg.	1.5 Meg.	12
CR39T	500 K	50 K	13
CR40T	1.0 Meg.	100 K	13
CR41	500	—	1
CR42	125 K	—	2
CR43	500 K	—	4
CR44	1.0 Meg.	—	4
CR45	2.0 Meg.	—	4
CR46	3.0 Meg.	—	4
CR47	5.0 Meg.	—	4
CR48T	7.5 K	3750	12
CR49T	10 K	5000	12
CR50T	20 K	6000	11
WR1	10 K	—	U
WR2	15 K	—	U

LISTING BY RESISTANCE VALUE			
OHMS	TAPS	TAPER*	STOCK NO.
100	—	1	CR1
500	—	1	CR41
750	—	5	CR27
1000	—	1	CR2
1000	—	5	CR28
2000	—	2	CR3
2000	—	4	CR25
5000	—	2	CR4
7500	3750	12	CR48T
10 K	—	2	CR5
10 K	—	4	CR26
10 K	5000	12	CR49T
20 K	6000	11	CR50T
25 K	—	2	CR6
50 K	—	2	CR7
100 K	—	2	CR8
125 K	—	2	CR42
200 K	—	2	CR9
250 K	—	2	CR10
250 K	—	3	CR18
250 K	60 K	11	CR29T
250 K	125 K	12	CR34T
350 K	—	3	CR19
350 K	75 K	11	CR30T
500 K	—	2	CR11
500 K	—	3	CR20
500 K	—	4	CR43
500 K	125 K	11	CR31T
500 K	250 K	12	CR35T
500 K	50 K	13	CR39T
1.0 Meg.	—	2	CR12
1.0 Meg.	—	3	CR21
1.0 Meg.	—	4	CR44
1.0 Meg.	250 K	11	CR32T
1.0 Meg.	500 K	12	CR36T
1.0 Meg.	100 K	13	CR40T
1.5 Meg.	—	2	CR13
2.0 Meg.	—	2	CR14
2.0 Meg.	—	3	CR22
2.0 Meg.	—	4	CR45
2.0 Meg.	500 K	11	CR33T
2.0 Meg.	1.0 Meg.	12	CR37T
2.5 Meg.	—	2	CR15
3.0 Meg.	—	2	CR16
3.0 Meg.	—	2	CR23
3.0 Meg.	—	4	CR46
3.0 Meg.	—	4	CR47
3.0 Meg.	1.5 Meg.	12	CR38T
5.0 Meg.	—	2	CR17
5.0 Meg.	—	3	CR24
5.0 Meg.	—	4	CR47
10 K	—	U	WR1
15 K	—	U	WR2

\* See Taper explanation chart, page 28

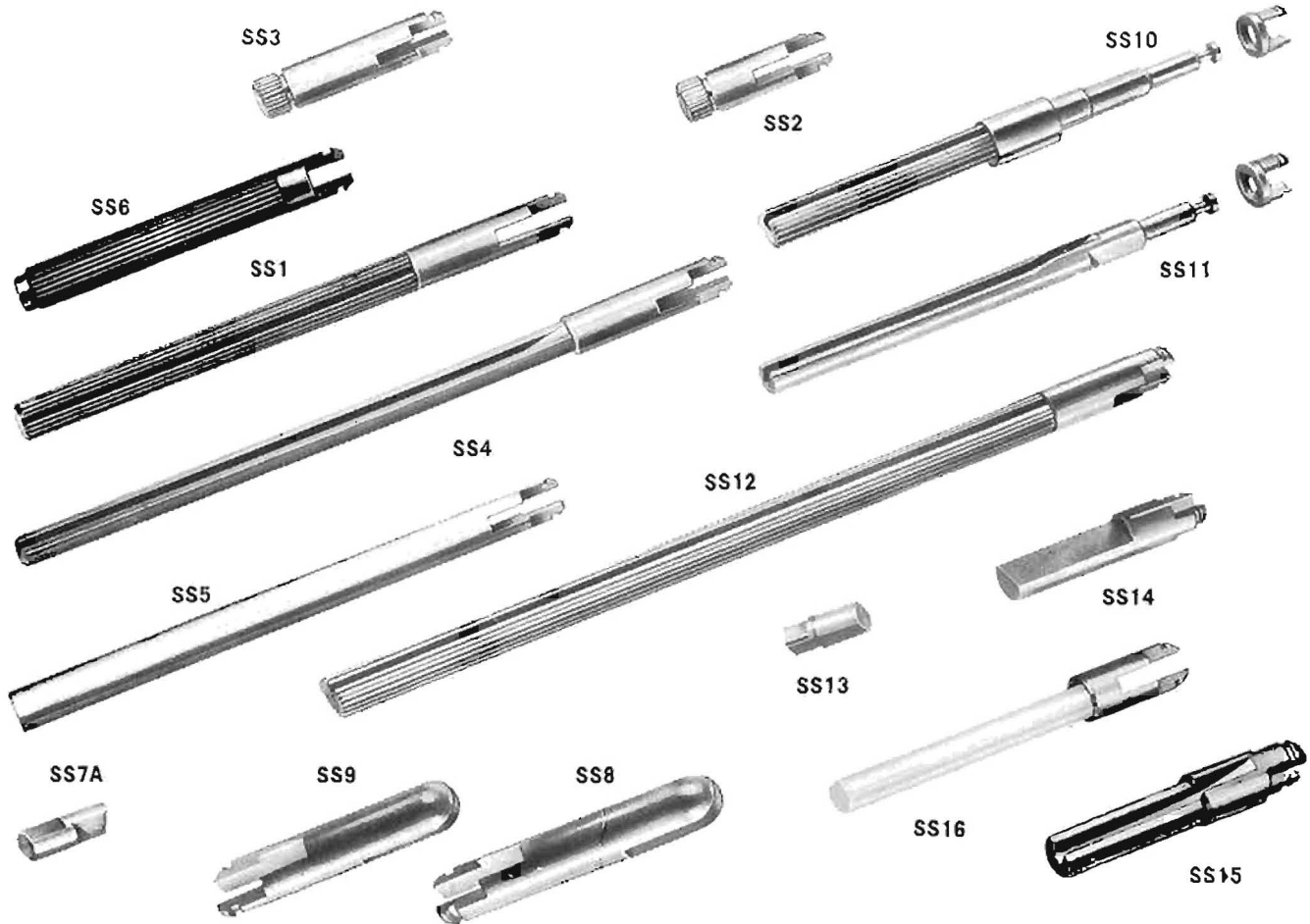

## SINGLE CONTROL SHAFTS

Universal single control shafts for SNAPTROL permit front sections to be used as universal single control replacements.

STOCK NO.	DESCRIPTION
SS1	KNOBMASTER Shaft, Knurled, grooved and slotted for universal use. 3" long F.M.S.
SS2	Short, screw-driver slotted shaft. 1/2" long, F.M.S.
SS3	Short knurled and screw-driver slotted shaft. 3/4" long, F.M.S.
SS4	3/16" diameter shaft. Flatted and grooved. 4" long F.M.S.
SS5	Full round 1/4" diameter shaft. 3" long F.M.S.
SS6	Insulated Shaft. 1/4" diameter x 1 3/8" long. Screw-driver slot and knurled full length.
SS7A	Intersection insert. Converts concentric rear section to tandem rear section with single shaft.
SS8	Special rounded end and slotted shaft for G. E. controls—.79" long F.M.S.

STOCK NO.	DESCRIPTION
SS9	Special rounded end and slotted shaft for G. E. controls-.60" long F.M.S.
SS10	For K switch (push-pull) operation with single Front Section. 3" Knobmaster Shaft (same as SS1) with insert.
SS11	For K switch (pull-push) operation with single Front Section. 2" long flatted and grooved 3/16" diameter shaft (similar to SS4) with insert.
SS12	Long Knobmaster Shaft. Same as SS1 but 5" long.
SS13	Multisection Insert. For use between second and third or successive tandem sections. (Note SS7A used between first and second sections.)
SS14	Short flatted shaft. 1/4" diameter by 3/4" long F.M.S., flatted full length. Provided for short, flatted tab mounted controls.
SS15	3/16" diameter shaft, flatted and grooved full length. 3/4" long F.M.S.
SS16	Insulated shaft, 3/16" diameter flatted full length. 1 1/2" long F.M.S.





# SNAPTROL

## POWER SWITCHES

SNAPTROL rotary and pull-push power switches snap on to carbon front or rear sections.

Stock No.	Description
GC	Rotary Power Switch, S.P.S.T.
K	Pull-push Power Switch, S.P.S.T.
VF	Rotary Power Switch, S.P.D.T.
WF	Rotary Power Switch, D.P.S.T.

## DUST COVER

Stock No.	Description
DC1	Dust Cover For use on either front or rear section when switch is not used.
DC2	Reverse Tab mount dust cover.



Type DC1



Type DC2



Type GC



Type K



Types VF/WF

## EXACT DUPLICATE SHAFTS

SNAPTROL Exact Duplicate Shafts are supplied to close tolerances against original control specifications. Easily snap into molded nylon rotors of front or rear sections. Uniform diameter of rear section (inner) shafts permit use of heavier wall on front section (outer) shafts providing better concentric rotation and superior knob fit. Knob Adapter (Stock No. KA1) fits rear (inner) shaft to knobs normally requiring larger diameter shafts. No drilling or modification of knobs is required. No cutting of shafts is needed with SNAPTROL Exact Duplicate Shafts! Easy to install!

Knob Adapter. Fits rear section shaft to knob requirements of over-size shaft. Converts .187" diameter shaft to .202" diameter shaft.

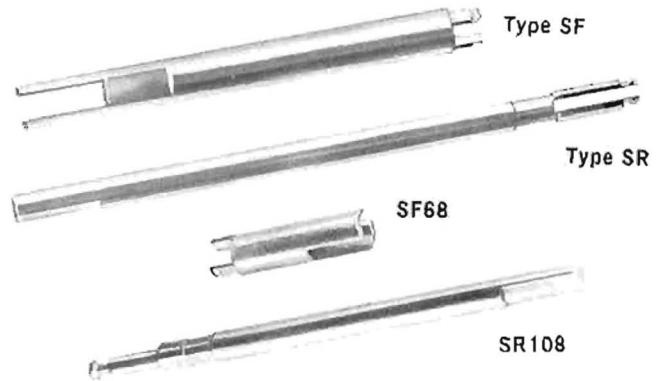

FRONT SECTION (OUTER) SHAFTS					
STOCK NO.	SHAFT LENGTH FMS*	SHAFT END*	STOCK NO.	SHAFT LENGTH FMS*	SHAFT END*
SF1	3/16"	S	SF35	3 3/32"	FS
SF2	2 1/4"	S	SF36	3 3/32"	FS
SF3	3/4"	FS	SF37	4"	FS
SF4	7/8"	FS	SF38	4 3/8"	FS
SF5	1 1/16"	FS	SF39	4 3/8"	FS
SF6	1"	FS	SF40	1 3/16"	FS
SF7	1 1/8"	FS	SF41	1"	FS
SF8	1 3/8"	FS	SF42	1 1/8"	FS
SF9	1 1/2"	FS	SF43	1 1/8"	FS
SF10	1 3/8"	FS	SF44	1 1/8"	FS
SF11	1 1/2"	FS	SF45	2"	FS
SF12	1 1/8"	FS	SF46	2 1/8"	FS
SF13	1 3/8"	FS	SF47	2 1/8"	FS
SF14	1 3/8"	FS	SF48	2 3/8"	FS
SF15	1 7/8"	FS	SF49	2 1/8"	FS
SF16	1 3/8"	FS	SF50	2 3/8"	FS
SF17	2"	FS	SF51	1 3/8"	FS
SF18	2 3/8"	FS	SF52	3 3/8"	FS
SF19	2 3/8"	FS	SF53	1"	FS
SF20	2 3/8"	FS	SF54	1 3/8"	FS
SF21	2 3/8"	FS	SF55	1 3/8"	FS
SF22	2 3/8"	FS	SF56	3 1/8"	FS
SF23	2 3/8"	FS	SF57	3 1/8"	FS
SF24	2 3/8"	FS	SF58	3 1/8"	FS
SF25	2 3/8"	FS	SF59	3 1/8"	FS
SF26	2 3/8"	FS	SF60	1"	FS
SF27	2 3/8"	FS	SF61	1 1/4"	FS
SF28	3"	FS	SF62	1 1/8"	FS
SF29	3 3/8"	FS	SF63	1 3/8"	FS
SF30	3 3/8"	FS	SF64	1 3/8"	FS
SF31	3 3/8"	FS	SF65	1 3/8"	FS
SF32	3 3/8"	FS	SF66	1 3/8"	FS
SF33	3 1/2"	FS	SF67	1 3/8"	FS
SF34	3 1/2"	FS	SF68	2 3/8"	FS

REAR SECTION (INNER) SHAFTS								
STOCK NO.	SHAFT LENGTH FMS*	SHAFT END*	STOCK NO.	SHAFT LENGTH FMS*	SHAFT END*	STOCK NO.	SHAFT LENGTH FMS*	SHAFT END*
SR1	1 1/8"	F	SR38	4 7/8"	F	SR75	7/8"	SD
SR2	1 3/8"	F	SR39	1 3/8"	F	SR76	2 3/8"	SD
SR3	1 3/8"	F	SR40	1 3/8"	F	SR77	2"	SP
SR4	1 3/8"	F	SR41	1 3/8"	F	SR78	3 3/8"	SP
SR5	1 3/8"	F	SR42	1 3/8"	F	SR79	3 1/2"	SP
SR6	1 3/8"	F	SR43	1 3/8"	F	SR80	4"	SP
SR7	1 3/8"	F	SR44	1 3/8"	F	SR81**	1 1/8"	F
SR8	1 3/8"	F	SR45	1 3/8"	F	SR82**	1 1/8"	F
SR9	1 3/8"	F	SR46	1 3/8"	F	SR83**	1 1/8"	F
SR10	1 3/8"	F	SR47	2"	F	SR84**	1 3/8"	F
SR11	1 3/8"	F	SR48	2 3/8"	F	SR85**	1 3/8"	F
SR12	2"	F	SR49	2 3/8"	F	SR86**	2 1/8"	F
SR13	2 3/8"	F	SR50	2 3/8"	F	SR87**	2"	F
SR14	2 3/8"	F	SR51	2 3/8"	F	SR88**	2 3/8"	F
SR15	2 3/8"	F	SR52	2 3/8"	F	SR89**	2 3/8"	F
SR16	2 3/8"	F	SR53	2 3/8"	F	SR90**	2 3/8"	F
SR17	2 3/8"	F	SR54	2 3/8"	F	SR91**	2 3/8"	F
SR18	2 3/8"	F	SR55	2 3/8"	F	SR92**	2 3/8"	F
SR19	2 3/8"	F	SR56	2 3/8"	F	SR93**	2 3/8"	F
SR20	2 3/8"	F	SR57	2 3/8"	F	SR94**	2 3/8"	F
SR21	2 3/8"	F	SR58	3"	F	SR95**	2 3/8"	F
SR22	2 3/8"	F	SR59	3 3/8"	F	SR96	1 3/8"	F
SR23	3"	F	SR60	3 3/8"	F	SR97	1 3/8"	F
SR24	3 3/8"	F	SR61	3 3/8"	F	SR98	3 3/8"	F
SR25	3 3/8"	F	SR62	3 3/8"	F	SR99	1 3/8"	F
SR26	3 3/8"	F	SR63	3 3/8"	F	SR100	3 3/8"	SD
SR27	3 3/8"	F	SR64	3/4"	K	SR101	3 3/8"	F
SR28	3 3/8"	F	SR65	1 1/8"	K	SR102**	2 3/8"	F
SR29	3 3/8"	F	SR66	1"	K	SR103**	2 3/8"	F
SR30	3 3/8"	F	SR67	1 3/8"	K	SR104**	2 3/8"	F
SR31	3 3/8"	F	SR68	1 3/8"	K	SR105**	2 3/8"	F
SR32	3 3/8"	F	SR69	1 3/8"	K	SR106**	3 3/8"	F
SR33	3 3/8"	F	SR70	1 3/8"	K	SR107	1 3/8"	F
SR34	4 3/8"	F	SR71	3/8"	SD	SR108**	2"	F
SR35	4 3/8"	F	SR72	1 3/8"	SD	SR109	3 3/8"	F
SR36	4 1/8"	F	SR73	2 3/8"	SD	SR10**	3 3/8"	F
SR37	4 1/8"	F	SR74	4 1/8"	SD			

\* FMS - Measured from mounting surface. F—Flat. FS—Flat & Slot. K—Knurled. S—Slot. SD—Screw-driver Slot. SP—Special.

\*\* Used with pull-push switch only.

# SNAPTROL DEALER STOCKS



## SPACIOUS STOCK CABINET

The same handsome stock cabinet is provided with either No. 87 or No. 89 stocks. Permits ready conversion of Basic Stock to Expanded Stock. Sturdy two-shelf metal cabinet measures 17 $\frac{7}{8}$ " wide, 11 $\frac{1}{16}$ " deep and 9" high. Provides twelve large "see-thru" plastic drawers with new locking divider feature. Drawers measure 11" deep, 4" wide and 2" high—956 cubic inches of stock space! All needed dividers are included. Both drawer front and bottom labels provide full location and identification data.

## WIDE COVERAGE OF CONTROL TYPES

SNAPTROL Dealer Control Stocks provide unusually wide variety of single, tandem and concentric dual control types. Included are nearly endless combinations of control mountings, shafts and power switches with both carbon ( $\frac{1}{2}$  watt) and wirewound (5 watts) front and rear sections. Control mountings include  $\frac{3}{8}$ ",  $\frac{7}{16}$ " and  $\frac{1}{2}$ " diameter bushings, tab mountings and printed circuit brackets. Shaft styles encompass  $\frac{1}{4}$ " and  $\frac{3}{16}$ " universal types, screw-driver slotted and insulated styles, rear adjustment feature, and a broad selection of exact duplicate shafts which require no cutting or modification.

Rotary and pull-push power switches attach to either single or concentric control styles. Concentric dual controls include carbon front end and rear sections, wirewound front and rear sections and wirewound front sections with carbon rear sections. Carbon units are equipped with printed circuit terminals for universal use. Broad selection of resistance values and tapers. Replacement data, pricing information and full instructions included.

## SNAPTROL DEALER CONTROL STOCKS

Geared to the real replacement control needs of servicing technicians, these new SNAPTROL stocks combine fast, snap-together assembly with unique, inventory-saving versatility. Carefully studied selections of SNAPTROL components assure broadest needed replacement coverage per dollar invested. Special attention has been given to actual component combinations needed for exact duplicate TV and Auto Set concentric dual controls.

Two carefully planned stocks are available. No. 87 is a Basic Stock. No. 89 is an Expanded Stock with nearly three times the replacement coverage. Both stocks are housed in a large metal cabinet with twelve "see-thru" drawers. Full identification of parts with unique labelling system. Basic stock may be changed to the expanded stock with No. 88 Conversion Stock.

## CONTENTS OF NEW DEALER SNAPTROL STOCKS

DESCRIPTION	BASIC STOCK	CONVERSION STOCK	EXPANDED STOCK
	No. 87	No. 88	No. 89
Carbon Front Sections	16	16	32
Wire Front Sections	—	7	7
Carbon Rear Sections	11	10	21
Wire Rear Section	—	1	1
Control Mountings	30	19	49
Single Control Shafts	13	23	36
Exact Duplicate Shafts	101	14	115
Power Switches (Rotary and Pull-Push)	18	—	18
Hardware Items	17	—	17
Replacement Manual	1	—	1
Instruction Package	1	—	1



# SNAPTROL/SERIES 45 INDUSTRIAL CONTROLS

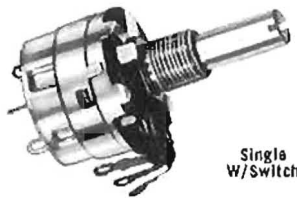

Single W/Switch

## IRC-CTS SERIES 45 CONTROLS

Designed to provide a wide variety of 1/2 watt controls for industrial applications, the Series 45 is a snap-together system in which selected values and sizes of five basic components will quickly assemble any of 12,631,500 specifications. Included are 25 values and tapers of single control or panel sections, 20 popular values of multi-sections or rear control sections, 20 most used shafts in length increments of 1/8" from 1/2" to 2" plus a 3" length, 2 rotary power switches and a control dust cover. Completely compatible and interchangeable with SNAPTROL, the Series 45 affords an extremely broad selection of mechanical and electrical specifications for industrial applications.

## SERIES 45 SNAP-IN SHAFTS

20 most often needed shafts for industrial applications. Provide screwdriver slot, flat, knurl or full round types in 1/8" increments from 1/2" to 2" in length. 3" length included. Broad shaft selection generally eliminates need for cutting or modification. All shafts 1/4" diameter.

STOCK NO.	LENGTH FMS	KNOB TRIM
01	1/2"	Screwdriver Slot
02	5/8"	Screwdriver Slot
03	3/4"	Screwdriver Slot
04	7/8"	Screwdriver Slot
05	1"	Screwdriver Slot
06	7/8"	.156 x 3/8" Flat
07	1"	.156 x 5/8" Flat
08	1 1/8"	.156 x 5/8" Flat
09	1 1/4"	.156 x 5/8" Flat
10	1 3/8"	.156 x 5/8" Flat
11	1 1/2"	.156 x 5/8" Flat
12	1 5/8"	.156 x 5/8" Flat
13	1 3/4"	.156 x 5/8" Flat
14	1 7/8"	.156 x 5/8" Flat
15	2"	.156 x 5/8" Flat
16	2"	Full Round
17	3"	Full Round
18	1"	Split Knurl
19	1 1/4"	Split Knurl
20	1 1/2"	Split Knurl

## POWER SWITCHES AND DUST COVER

Snap on to either panel or rear sections. Dust cover used where switch is not required.



Type D/S



Type 45C

STOCK NO.	DESCRIPTION
D	DPST Power Switch (Snaptrol WF)
S	SPST Power Switch (Snaptrol GC)
45C	Dust Cover (Snaptrol DC1)

**SINGLE CONTROL OR FRONT SECTIONS.** 25 most used resistance values in two resistance tapers: 45A logarithmic taper and 45D linear taper. Rated at 1/2 watt (linear taper). Equipped with 3/8"-32x3/8" long bushing for 1/4" diameter shafts. Mounting nut included. Resistance tolerance +20%.

## LISTING BY STOCK NUMBER

Stock No.	Ohms	CTS Taper	Similar To Snaptrol No.
45A103	10 K	A	CF61
45A104	100 K	A	CF52
45A105	1.0 Meg	A	CF26
45A205	2.0 Meg	A	CF27
45A254	250 K	A	CF23
45A305	3.0 Meg	A	CF28
45A503	50 K	A	CF63
45A504	500 K	A	CF25
45D102	1000	D	CF6
45D103	10 K	D	CF9
45D104	100 K	D	CF13
45D105	1.0 Meg	D	CF17
45D106	10.0 Meg	D	CF70
45D202	2000	D	—
45D203	20 K	D	CF62
45D204	200 K	D	CF14
45D205	2.0 Meg	D	CF19
45D253	25 K	D	CF11
45D254	250 K	D	CF15
45D302	3000	D	CF59
45D501	500	D	CF4
45D502	5000	D	CF8
45D503	50 K	D	CF12
45D504	500 K	D	CF16
45D505	5.0 Meg	D	CF22

## LISTING BY RESISTANCE VALUE

Stock No.	Ohms	CTS Taper	Similar To Snaptrol No.
45D501	500	D	CF4
45D102	1000	D	CF6
45D202	2000	D	—
45D302	3000	D	CF59
45D502	5000	D	CF8
45A103	10 K	A	CF61
45D103	10 K	D	CF9
45D203	20 K	D	CF62
45D253	25 K	D	CF11
45A503	50 K	A	CF63
45D503	50 K	D	CF12
45A104	100 K	A	CF52
45D104	100 K	D	CF13
45D204	200 K	D	CF14
45A254	250 K	A	CF23
45D254	250 K	D	CF15
45A504	500 K	A	CF25
45D504	500 K	D	CF16
45A105	1.0 Meg	A	CF26
45D105	1.0 Meg	D	CF17
45A205	2.0 Meg	A	CF27
45D205	2.0 Meg	D	CF19
45A305	3.0 Meg	A	CF28
45D505	5.0 Meg	D	CF22
45D106	10.0 Meg	D	CF70

\* See Taper chart, page 28

# SNAPTROL/SERIES 45 INDUSTRIAL CONTROLS



## IRC-CTS SERIES 45 MULTISECTIONS

20 rear sections snap on to panel section or to successive rear sections. Provide dual, triple or quadruple section controls. May be used with or without switch. M45A is logarithmic taper; M45D is linear taper. Resistance tolerance  $\pm 20\%$ . Power rating  $\frac{1}{2}$  watt (linear taper).

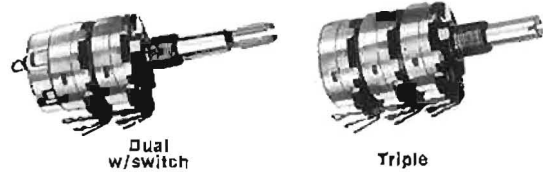

LISTING BY STOCK NUMBER			
STOCK NO.	OHMS	CTS TAPER*	SIMILAR TO SNAPTROL NO. PLUS SS7A
M45A104	100 K	A	—
M45A105	1.0 Meg	A	CR21
M45A205	2.0 Meg	A	CR22
M45A254	250 K	A	CR18
M45A504	500 K	A	CR20
M45D102	1000	D	CR2
M45D103	10 K	D	CR5
M45D104	100 K	D	CR8
M45D105	1.0 Meg	D	CR12
M45D106	10.0 Meg	D	—
M45D202	2000	D	CR3
M45D205	2.0 Meg	D	CR14
M45D253	25 K	D	CR6
M45D254	250 K	D	CR10
M45D302	3000	D	—
M45D501	500	D	CR41
M45D502	5000	D	CR4
M45D503	50 K	D	CR7
M45D504	500 K	D	CR11
M45D505	5.0 Meg	D	CR17

LISTING BY RESISTANCE VALUE			
OHMS	CTS TAPER*	STOCK NO.	SIMILAR TO SNAPTROL NO. PLUS SS7A
500	D	M45D501	CR41
1000	D	M45D102	CR2
2000	D	M45D202	CR3
3000	D	M45D302	—
5000	D	M45D502	CR4
10 K	D	M45D103	CR5
25 K	D	M45D253	CR6
50 K	D	M45D503	CR7
100 K	A	M45A104	—
100 K	D	M45D104	CR8
250 K	A	M45A254	CR18
250 K	D	M45D254	CR10
500 K	A	M45A504	CR20
500 K	D	M45D504	CR11
1.0 Meg	A	M45A105	CR21
1.0 Meg	D	M45D105	CR12
2.0 Meg	A	M45A205	CR22
2.0 Meg	D	M45D205	CR14
5.0 Meg	D	M45D505	CR17
10.0 Meg	D	M45D106	—

\* See Taper chart, page 28

## IDENTIFY ANY OF 12,631,500 SERIES 45 CONTROLS WITH THIS SPECIFICATION NUMBER SELECTION CHART

Suppose triple controls are wanted with these specifications, 500K log taper panel section, 10-meg linear taper second section, 10K ohms linear taper third section, plus SPST switch and a  $1\frac{1}{2}$ " split-knurled shaft. The specification number would be 45A504D106D103S20, derived from this chart as follows: 45 for Series 45, A504 for the panel section, D106 for the second and D103 for the third sections, S for SPST switch (symbol omitted if no switch wanted) and 20 for the desired shaft. Omit codes of unwanted features. Ex: 45D50116 for single control. This is a linear taper 500 ohm control with #16 shaft (2" full round), no switch.

Ohms	Type	Single Control or Panel Section		Second Section		Third Section		Fourth Section		Switch	Shaft	Shaft Detail	
		Log. Taper	Linear Taper	Log. Taper	Linear Taper	Log. Taper	Linear Taper	Log. Taper	Linear Taper			Length FMS	End Trim
500	45	—	D501	—	D501	—	D501	—	D501	D	01	$\frac{1}{2}$ "	SD SLOT
1000		—	D102	—	D102	—	D102	—	D102		02	$\frac{5}{8}$ "	SD SLOT
2000		—	D202	—	D202	—	D202	—	D202		03	$\frac{3}{4}$ "	SD SLOT
3000		—	D302	—	D302	—	D302	—	D302		04	$\frac{7}{8}$ "	SD SLOT
5000		—	D502	—	D502	—	D502	—	D502		05	1"	SD SLOT
10 K		A103	D103	—	D103	—	D103	—	D103	(DPST)	06	$\frac{7}{8}$ "	FLAT
20 K		—	D203	—	—	—	—	—	—	—	07	1"	FLAT
25 K		—	D253	—	D253	—	D253	—	D253	S	08	$1\frac{1}{8}$ "	FLAT
50 K		A503	D503	—	D503	—	D503	—	D503	(SPST)	09	$1\frac{1}{4}$ "	FLAT
100 K		A104	D104	A104	D104	A104	D104	A104	D104	—	10	$1\frac{3}{8}$ "	FLAT
200 K		—	D204	—	—	—	—	—	—	OMIT	11	$1\frac{1}{2}$ "	FLAT
250 K		A254	D254	A254	D254	A254	D254	A254	D254	FOR	12	$1\frac{5}{8}$ "	FLAT
500 K		A504	D504	A504	D504	A504	D504	A504	D504	NO	13	$1\frac{3}{4}$ "	FLAT
1 MEG		A105	D105	A105	D105	A105	D105	A105	D105	SWITCH	14	$1\frac{7}{8}$ "	FLAT
2 MEG		A205	D205	A205	D205	A205	D205	A205	D205	—	15	2"	FLAT
3 MEG		A305	—	—	—	—	—	—	—	—	16	2"	ROUND
5 MEG		—	D505	—	D505	—	D505	—	D505	—	17	3"	ROUND
10 MEG		—	D106	—	D106	—	D106	—	D106	—	18	1"	KNURL
											19	$1\frac{1}{4}$ "	KNURL
											20	$1\frac{1}{2}$ "	KNURL



# SNAPTROL/SERIES 45 INDUSTRIAL CONTROL STOCKS



**ENGINEERING LAB STOCKS.** Series 45, 1/2 watt controls to meet more than 12 million requirements. Two IRC engineering lab stocks include snap-together sections, control shafts, switches and dust covers. Ideal for building breadboards and prototypes. Grey metal cabinets stack or hang. Clear plastic drawers are labeled and separated for easy inventory and stock control.

## ENGINEERING LAB STOCK ELS #1

39 CTS-IRC single controls, 42 shafts,  
12 switches, 42 dust covers, 1 cabinet

### CONTROL SECTIONS

Quantity	Item	Ohms	Type Taper	Description
2	45A103	10K	Log Taper	Front Section
2	45A104	100K	Log Taper	Front Section
2	45A105	1 Meg	Log Taper	Front Section
2	45A254	250K	Log Taper	Front Section
2	45A503	50K	Log Taper	Front Section
2	45A504	500K	Log Taper	Front Section
3	45D102	1000	Linear Taper	Front Section
3	45D103	10K	Linear Taper	Front Section
3	45D104	100K	Linear Taper	Front Section
3	45D105	1 Meg	Linear Taper	Front Section
3	45D253	25K	Linear Taper	Front Section
3	45D254	250K	Linear Taper	Front Section
3	45D503	50K	Linear Taper	Front Section
3	45D504	500K	Linear Taper	Front Section
3	45D505	5 Meg	Linear Taper	Front Section

## ENGINEERING LAB STOCK ELS #2

102 CTS-IRC single and multiple section controls, 64 shafts, 20 switches,  
44 dust covers, 2 metal cabinets.

### CONTROL SECTIONS

Quantity	Item	Ohms	Type Taper	Description
4	45A103	10K	Log Taper	Front Section
4	45A104	100K	Log Taper	Front Section
4	45A105	1 Meg	Log Taper	Front Section
4	45A254	250K	Log Taper	Front Section
4	45A503	50K	Log Taper	Front Section
4	45A504	500K	Log Taper	Front Section
4	45D102	1000	Linear Taper	Front Section
4	45D103	10K	Linear Taper	Front Section
4	45D104	100K	Linear Taper	Front Section
4	45D105	1 Meg	Linear Taper	Front Section
4	45D253	25K	Linear Taper	Front Section
4	45D254	250K	Linear Taper	Front Section
4	45D502	5000	Linear Taper	Front Section
4	45D503	50K	Linear Taper	Front Section
4	45D504	500K	Linear Taper	Front Section
4	45D505	5 Meg	Linear Taper	Front Section
2	M45A104	100K	Log Taper	Rear Section
2	M45A105	1 Meg	Log Taper	Rear Section
2	M45A254	250K	Log Taper	Rear Section
2	M45A504	500K	Log Taper	Rear Section
2	M45D102	1000	Linear Taper	Rear Section
4	M45D103	10K	Linear Taper	Rear Section
4	M45D104	100K	Linear Taper	Rear Section
4	M45D105	1 Meg	Linear Taper	Rear Section
2	M45D253	25K	Linear Taper	Rear Section
2	M45D254	250K	Linear Taper	Rear Section
2	M45D502	5000	Linear Taper	Rear Section
4	M45D503	50K	Linear Taper	Rear Section
4	M45D504	500K	Linear Taper	Rear Section
2	M45D505	5 Meg	Linear Taper	Rear Section

### SWITCHES AND COVERS

Quantity	Item	Description
3	DPST	Rotary type, 3 amps at 125 volts, 1 amp at 250 volts, 5 amps at 20 volts, AC. UL approved.
9	SPST	Rotary type, 3 amps at 125 volts, 1 amp at 250 volts, AC. UL approved.
42	45C	Snap-on Cover.

### SHAFTS

Quantity	Item	Length	End Trim
2	01	1/2"	SD Slot
2	02	5/8"	SD Slot
3	03	3/4"	SD Slot
2	04	7/8"	SD Slot
3	05	1"	SD Slot
2	06	7/8"	Flat
2	07	1"	Flat
2	08	1 1/8"	Flat
3	09	1 1/4"	Flat
2	10	1 3/8"	Flat
2	11	1 1/2"	Flat
2	12	1 5/8"	Flat
2	13	1 3/4"	Flat
2	14	1 7/8"	Flat
2	15	2"	Flat
2	16	2"	Round
3	17	3"	Round
2	18	1"	Knurl
2	19	1 1/4"	Knurl

### SWITCHES AND COVERS

Quantity	Item	Description
5	DPST	Rotary type, 3 amps at 125 volts, 1 amp at 250 volts, 5 amps at 20 volts, AC. UL approved.
15	SPST	Rotary type, 3 amps at 125 volts, 1 amp at 250 volts, AC. UL approved.
44	45C	Snap-on cover.

### SHAFTS

Quantity	Item	Length	End Trim
5	01	1/2"	SD Slot
2	02	5/8"	SD Slot
5	03	3/4"	SD Slot
5	04	7/8"	SD Slot
5	05	1"	SD Slot
5	06	7/8"	Flat
2	07	1"	Flat
2	08	1 1/8"	Flat
2	09	1 1/4"	Flat
2	10	1 3/8"	Flat
2	11	1 1/2"	Flat
2	12	1 5/8"	Flat
2	13	1 3/4"	Flat
2	14	1 7/8"	Flat
2	15	2"	Flat
5	16	2"	Round
5	17	3"	Round
5	18	1"	Knurl
2	19	1 1/4"	Knurl
2	20	1 1/2"	Knurl

# CONCENTRIKIT TYPE Q



## IRC-CTS TYPE Q CONTROLS AND BASE ELEMENTS

Type Q Replacement Controls and the versatile Type Q Base-Element provide the broadest selection of resistance values and tapers. Type Q is equipped with 3" long Knobmaster Shaft—flatted, grooved and knurled for universal knob fit. Bushing  $\frac{3}{8}$ —32 by  $\frac{1}{4}$ " long FMS. Stock numbers in parentheses ( ) may be assembled with Base-Element indicated and SK1 Kit. PPQ items may be assembled with Base-Element listed and either SK7 or SK8 as required.

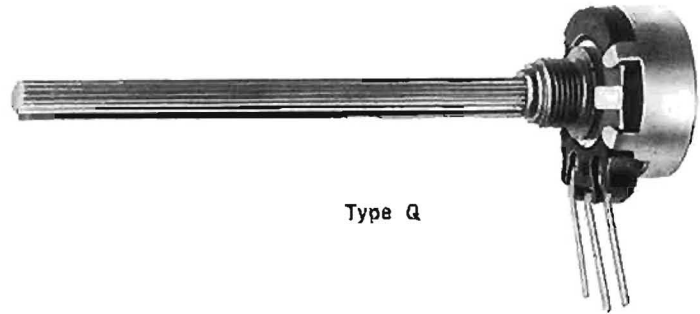

Type Q

### LISTING BY RESISTANCE VALUE

OHMS	TAP	TAPER*	Q CONTROL STOCK NO.**	Q BASE-ELEMENT STOCK NO.
100	—	1 (A)	(Q11-084)	B11-084
250	—	2 (A)	Q11-201	B11-201
300	—	1 (A)	(Q11-102)	B11-102
500	—	1 (A)	Q11-103	B11-103
500	—	5 (P)	(Q17-103)	B17-103
500	60	14 (S)	(Q17-103X)	B17-103X
750	—	1 (A)	Q11-105	B11-105
750	—	5 (P)	Q17-105	B17-105
750	250	8 (S)	Q17-105X	B17-105X
1000	—	2 (A)	Q11-108	B11-108
1000	—	5 (P)	Q17-108	B17-108
1000	150	20 (S)	(Q17-108X)	B17-108X
1200	—	4 (Q)	(Q17-208)	B17-208
1500	—	2 (A)	Q11-109	B11-109
1500	—	4 (Q)	Q17-109	B17-109
1500	180	27 (S)	(Q15-109X)	B15-109X
1500	185 & 375	34 (S)	(Q17-109XX)	B17-109XX
2000	—	2 (A)	Q11-110	B11-110
2000	—	4 (Q)	Q17-110	B17-110
2000	550	38 (S)	(Q17-110X)	B17-110X
2000	250 & 500	34 (S)	Q17-110XX	B17-110XX
2500	—	2 (A)	(Q11-111)	B11-111
2500	—	3 (C)	Q13-111	B13-111
2500	—	4 (Q)	Q17-111	B17-111
2500	250	13 (S)	(Q15-111X)	B15-111X
2500	500	21 (S)	(Q17-111X)	B17-111X
2500	625	28 (S)	(Q27-111X)	B27-111X
3000	—	2 (A)	Q11-112	B11-112
3000	—	4 (Q)	Q17-112	B17-112
3000	150	9 (S)	(Q17-112X)	B17-112X
5000	—	2 (A)	Q11-114	B11-114
5000	—	3 (C)	Q13-114	B13-114
5000	—	4 (Q)	Q17-114	B17-114
5000	500	13 (S)	(Q15-114X)	B15-114X
5000	1000	21 (S)	(Q17-114X)	B17-114X
7500	—	2 (A)	Q11-115	B11-115
7500	3750	12	(Q21-115X)	B21-115X
10 K	—	2 (A)	Q11-116***	B11-116
10 K	—	3 (C)	Q13-116	B13-116
10 K	—	23 (D)	Q14-116***	B14-116
10 K	—	4 (Q)	Q17-116	B17-116
10 K	300	22 (S)	(Q15-116X)	B15-116X
10 K	5000	12	(Q19-116X)	B19-116X

### LISTING BY RESISTANCE VALUE

OHMS	TAP	TAPER*	Q CONTROL STOCK NO.**	Q BASE-ELEMENT STOCK NO.
11.5 K	—	5 (Q)	(Q17-117)	B17-117
15 K	—	2 (A)	(Q11-118)	B11-118
15 K	5000	29 (S)	Q17-118X	B17-118X
15 K	10 K	8 (S)	Q13-118X	B13-118X
15 K	5000 & 10 K	33 (S)	Q13-118XX	B13-118XX
15 K	5000 & 10 K	48 (S)	Q17-118XX	B17-118XX
20 K	—	2 (A)	Q11-119	B11-119
20 K	—	4 (Q)	(Q17-119)	B17-119
20 K	—	45 (S)	Q16-119***	B16-119
20 K	6000	11	(Q19-119X)	B19-119X
25 K	—	2 (A)	Q11-120	B11-120
25 K	—	3 (C)	Q13-120	B13-120
25 K	—	23 (D)	Q14-120	B14-120
25 K	—	4 (Q)	(Q17-120)	B17-120
30 K	—	2 (A)	Q11-121	B11-121
30 K	10 K	8 (S)	(Q20-121X)	B20-121X
35 K	—	2 (A)	Q11-122	B11-122
50 K	—	2 (A)	Q11-123	B11-123
50 K	—	3 (C)	Q13-123	B13-123
50 K	—	23 (D)	Q14-123***	B14-123
50 K	—	4 (Q)	(Q17-123)	B17-123
75 K	—	2 (A)	Q11-125	B11-125
100 K	—	2 (A)	Q11-128	B11-128
100 K	—	3 (C)	Q13-128	B13-128
100 K	—	4 (Q)	(Q17-128)	B17-128
125 K	—	2 (A)	Q11-228	B11-228
150 K	—	2 (A)	Q11-328	B11-328
150 K	—	3 (C)	Q13-328	B13-328
150 K	19 K & 38 K	34 (S)	Q17-328XX	B17-328XX
200 K	—	2 (A)	Q11-129	B11-129
200 K	—	4 (Q)	(Q17-129)	B17-129
250 K	—	2 (A)	Q11-130	B11-130
250 K	—	3 (C)	Q13-130	B13-130
250 K	60 K	44 (H)	Q18-130X	B18-130X
250 K	125 K	12 (S)	Q13-130X	B13-130X
250 K	60 K & 120 K	46 (S)	Q18-130XX	B18-130XX
300 K	—	2 (A)	Q11-131	B11-131
350 K	—	2 (A)	Q11-132	B11-132
350 K	—	3 (C)	Q13-132	B13-132
350 K	35 K	13 (S)	Q17-132X	B17-132X
350 K	75 K	30 (H)	Q18-132X	B18-132X
400 K	—	2 (A)	(Q11-232)	B11-232

\* Taper listing shows both new (numerical) Taper and old (alphabetical) Taper. See Taper explanation chart, page 28.

\*\* Stock numbers listed in parentheses ( ) are not available as factory-assembled controls. Use Q Base-Element shown with SK1 Kit for field assembly of such items.

\*\*\* Supplied with 270Ω bias resistor.

LISTING CONTINUED ON NEXT PAGE



# CONCENTRIKIT TYPE Q



PLAIN BASE ELEMENT



SINGLE TAPPED  
BASE ELEMENT



DOUBLE TAPPED  
BASE ELEMENT

## LISTING BY RESISTANCE VALUE

OHMS	TAP	TAPER*	Q CONTROL STOCK NO.**	Q BASE-ELEMENT STOCK NO.
500 K	—	2 (A)	Q11-133	B11-133
500 K	—	3 (C)	Q13-133	B13-133
500 K	—	23 (D)	Q14-133	B14-133
500 K	—	4 (Q)	Q17-133	B17-133
500 K	25 K	40 (S)	Q17-133X	B17-133X
500 K	50 K	13 (S)	Q18-133X	B18-133X
500 K	75 K	24 (S)	(Q15-133X)	B15-133X
500 K	125 K	44 (H)	Q13-133X	B13-133X
500 K	180 K	31 (S)	(Q20-133X)	B20-133X
500 K	250 K	12 (S)	Q19-133X	B19-133X
500 K	100K & 200K	35 (S)	Q18-133XX	B18-133XX
500 K	167K & 330K	17 (S)	(Q20-133XX)	B20-133XX
600 K	—	2 (A)	Q11-134	B11-134
750 K	—	2 (A)	Q11-136	B11-136
1.0 M	—	2 (A)	Q11-137	B11-137
1.0 M	—	3 (C)	Q13-137	B13-137
1.0 M	—	23 (D)	Q14-137	B14-137
1.0 M	—	4 (Q)	Q17-137	B17-137
1.0 M	35 K	22 (S)	Q17-137X	B17-137X
1.0 M	100 K	13 (S)	Q18-137X	B18-137X
1.0 M	250 K	44 (H)	Q13-137X	B13-137X
1.0 M	500 K	12 (S)	Q19-137X	B19-137X
1.0 M	500 K	32 (S)	QVC-539X	BVC-539X
1.0 M	50K & 100K	36 (S)	Q17-137XX	B17-137XX
1.0 M	250K & 500K	18 (S)	Q18-137XX	B18-137XX
1.25 M	—	4 (Q)	(Q17-237)	B17-237
1.25 M	750 K	10 (S)	(Q18-237X)	B18-237X
1.5 M	—	2 (A)	Q11-138	B11-138
1.5 M	—	3 (C)	(Q13-138)	B13-138
1.5 M	—	4 (Q)	(Q17-138)	B17-138
1.5 M	250 K	26 (S)	Q13-138X	B13-138X
2.0 M	—	2 (A)	Q11-139	B11-139
2.0 M	—	3 (C)	Q13-139	B13-139
2.0 M	—	4 (Q)	Q17-139	B17-139
2.0 M	50 K	22 (S)	Q19-139X	B19-139X
2.0 M	150 K	37 (S)	Q17-139X	B17-139X
2.0 M	500 K	44 (H)	Q13-139X	B13-139X
2.0 M	1.0 M	12 (S)	Q18-139X	B18-139X
2.0 M	250K & 500K	43 (S)	Q18-139XX	B18-139XX
2.0 M	500K & 1.0M	18 (S)	Q13-139XX	B13-139XX
2.5 M	—	2 (A)	Q11-239	B11-239
2.5 M	—	4 (Q)	(Q17-239)	B17-239
3.0 M	—	2 (A)	Q11-140	B11-140

## LISTING BY RESISTANCE VALUE

OHMS	TAP	TAPER*	Q CONTROL STOCK NO.**	Q BASE-ELEMENT STOCK NO.
3.0 M	—	3 (C)	Q13-140	B13-140
3.0 M	—	4 (Q)	Q17-140	B17-140
3.0 M	900 K	47 (S)	Q13-140X	B13-140X
3.0 M	1.5 M	12 (S)	Q18-140X	B18-140X
4.0 M	—	2 (A)	(Q11-240)	B11-240
4.0 M	open at 25 K	39 (S)	(Q-12-240)	B12-240
5.0 M	—	2 (A)	Q11-141	B11-141
5.0 M	—	6 (S)	Q12-141	B12-141
5.0 M	—	3 (C)	Q13-141	B13-141
5.0 M	—	4 (Q)	Q17-141	B17-141
5.0 M	—	7 (S)	(Q12-241)	B12-241
5.0 M	open at 500 K	41 (S)	(Q12-341)	B12-341
5.0 M	1.0 M	30 (S)	(Q13-141X)	B13-141X
5.0 M	2.5 M	12 (S)	(Q18-141X)	B18-141X
7.5 M	—	2 (A)	Q11-142	B11-142
10.0 M	—	2 (A)	Q11-143	B11-143

## FACTORY-ASSEMBLED TYPE Q CONTROL WITH PULL-PUSH SWITCH

OHMS	TAP	TAPER*	Q CONTROL STOCK NO.	Q BASE-ELEMENT STOCK NO.
500	—	2 (A)	PPQ11-103-SK7	B11-103
200 K	—	2 (A)	PPQ11-129-SK7	B11-129
250 K	—	3 (C)	PPQ13-130-SK7	B13-130
500 K	—	3 (C)	PPQ13-133-SK7	B13-133
500 K	125 K	44 (H)	PPQ13-133X-SK8	B13-133X
1.0 M	—	2 (A)	PPQ11-137-SK7	B11-137
1.0 M	—	2 (A)	PPQ11-137-SK8	B11-137
1.0 M	—	3 (C)	PPQ13-137-SK7	B13-137
1.0 M	—	3 (C)	PPQ13-137-SK8	B13-137
1.0 M	100 K	13 (S)	PPQ18-137X-SK8	B18-137X
1.0 M	250 K	44 (H)	PPQ13-137X-SK7	B13-137X
1.0 M	250 K	44 (H)	PPQ13-137X-SK8	B13-137X
1.0 M	500 K	12 (S)	PPQ19-137X-SK8	B19-137X
2.0 M	—	3 (C)	PPQ13-139-SK8	B13-139
2.0 M	1.0 M	12 (S)	PPQ18-139X-SK7	B18-139X
2.0 M	1.0 M	12 (S)	PPQ18-139X-SK8	B18-139X
3.0 M	1.5 M	12 (S)	PPQ18-140X-SK8	B18-140X

\* Taper listing shows both new (numerical) Taper and old (alphabetical) Taper. See Taper explanation chart, page 28.

\*\* Stock numbers listed in parentheses ( ) are not available as factory-assembled controls. Use Q Base-Element shown with SK1 Kit for field assembly of such items.

# TYPE 4W CONTROLS AND BASE ELEMENTS



Types WPK and WPS are compact, 1/4" diameter wire wound controls available for replacement use in two popular shaft styles and an extensive variety of resistance values and tapers. Many stock numbers can be supplied as factory-assembled units. All stock numbers may be assembled in field using Base-Element with SK4 or SK5 Kit as desired.

Resistance elements are uniformly wound with highest grade alloy resistance wire on special form that withstands high temperature without shrinking. Pressure molded plastic housing is designed for maximum heat dissipation and accurate location of terminals. Contactor and collector are of long-wearing alloy that makes direct contact.

Resistance tolerance is . 10%

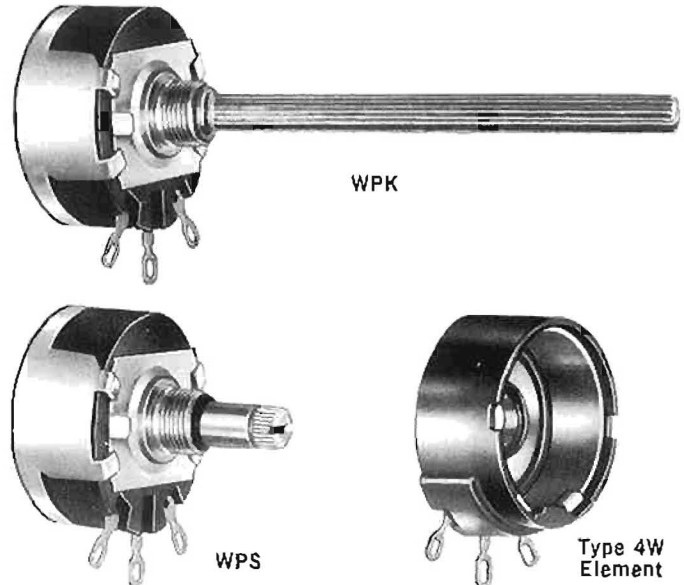

LISTING BY RESISTANCE VALUE					
OHMS	TAP	TYPE WPK TAPER STOCK NO.*	TYPE WPS STOCK NO.*	4W BASE-ELEMENT STOCK NO.	
10	—	U WPK10	(WPS10)	W11-010	
10	5	U (WPK10X5)	WPS10X5	W11-010X	
15	7.5	U (WPK15X7.5)	WPS15X7.5	W11-015X	
20	—	U WPK20	(WPS20)	W11-020	
20	10	U (WPK20X10)	WPS20X10	W11-020X	
25	—	U (WPK25)	WPS25	W11-025	
25	12.5	U (WPK25X12.5)	WPS25X12.5	W11-025X	
30	—	U WPK30	(WPS30)	W11-030	
30	15	U (WPK30X15)	WPS30X15	W11-030X	
40	—	U (WPK40)	WPS40	W11-040	
40	20	U (WPK40X20)	WPS40X20	W11-040X	
50	—	U WPK50	(WPS50)	W11-050	
50	25	U (WPK50X25)	WPS50X25	W11-050X	
60	—	U (WPK60)	WPS60	W11-060	
80	40	U (WPK80X40)	WPS80X40	W11-080X	
100	—	U WPK100	(WPS100)	W11-084	
100	50	U (WPK100X50)	WPS100X50	W11-084X	
140	70	U (WPK140X70)	WPS140X70	W11-092X	
150	75	U (WPK150X75)	WPS150X75	W11-094X	
200	—	U WPK200	(WPS200)	W11-100	
200	100	U (WPK200X100)	WPS200X100	W11-100X	
250	—	U WPK250	WPS250	W11-201	
300	—	U WPK300	(WPS300)	W11-102	
400	—	U WPK400	(WPS400)	W11-202	
500	—	U WPK500	WPS500	W11-103	
500	—	L (WPK500L)	WPS500L	W13-103	
600	—	U WPK600	(WPS600)	W11-104	
650	—	U WPK650	(WPS650)	W11-204	
750	—	U WPK750	(WPS750)	W11-105	
750	—	L WPK750L	(WPS750L)	W13-105	
750	—	R WPK750R	(WPS750R)	W17-105	
750	250	S (WPK750X250)	(WPS750X250)	W17-105X	

LISTING BY RESISTANCE VALUE					
OHMS	TAP	TYPE WPK TAPER STOCK NO.*	TYPE WPS STOCK NO.	4W BASE-ELEMENT STOCK NO.	
1000	—	U WPK1000	WPS1000	W11-108	
1350	—	U WPK1350	(WPS1350)	W11-308	
1350	—	R WPK1350R	(WPS1350R)	W17-308	
1500	—	U WPK1500	WPS1500	W11-109	
1500	—	L WPK1500L	(WPS1500L)	W13-109	
1500	500	S (WPK1500X500)	(WPS1500X500)	W17-109X	
2000	—	U WPK2000	WPS2000	W11-110	
2000	—	L WPK2000L	(WPS2000L)	W13-110	
2250	—	U (WPK2250)	WPS2250	W11-210	
2250	—	L WPK2250L	WPS2250L	W13-210	
2500	—	U WPK2500	WPS2500	W11-111	
2500	—	R WPK2500R	(WPS2500R)	W17-111	
3000	—	U WPK3000	WPS3000	W11-112	
3000	—	R (WPK3000R)	(WPS3000R)	W17-112	
3300	—	L (WPK3300L)	(WPS3300L)	W13-212	
4000	—	U (WPK4000)	WPS4000	W11-113	
4000	—	L WPK4000L	WPS4000L	W13-113	
5000	—	U WPK5000	WPS5000	W11-114	
5000	—	L WPK5000L	(WPS5000L)	W13-114	
5000	—	R (WPK5000R)	(WPS5000R)	W17-114	
6000	—	U WPK6000	(WPS6000)	W11-214	
6000	—	L WPK6000L	(WPS6000L)	W13-214	
7500	—	U WPK7500	(WPS7500)	W11-115	
7500	—	L WPK7500L	(WPS7500L)	W13-115	
10 K	—	U WPK10000	WPS10000	W11-116	
12.5 K	—	U WPK12500	(WPS12500)	W11-217	
15 K	—	U WPK15000	(WPS15000)	W11-118	
20 K	—	U WPK20000	(WPS20000)	W11-119	
25 K	—	U WPK25000	(WPS25000)	W11-120	
30 K	—	U WPK30000	(WPS30000)	W11-121	
40 K	—	U WPK40000	(WPS40000)	W11-222	
50 K	—	U WPK50000	(WPS50000)	W11-123	

\* Stock numbers listed in parentheses ( ) are not available as factory-assembled controls. Use 4W Base-Element shown with SK4 Kit (for WPK) or SK5 Kit (for WPS). See Taper explanation chart, page 28.





# CONCENTRIKIT TYPE Q & 4W PARTS

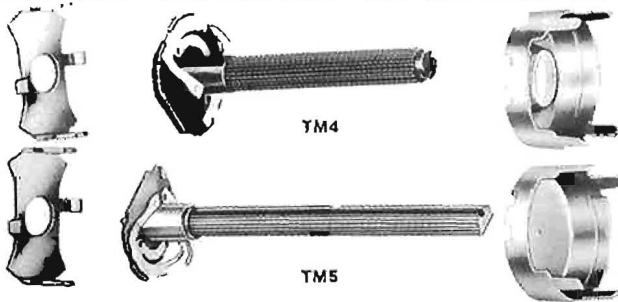

## SHAFT KITS FOR TAB-MOUNTED CONTROLS

Similar to SK Kits, the TM series provide tab-mounting plate instead of bushing. Metal-cased 76-1, 76-2 and 76-4 may be used with this series. Kits include shaft, tab-mount plate and cover.

Stock No.	Description
TM1	1/4" diameter shaft, 1/4" long FMS. Screwdriver slot and short knurl.
TM2	1/4" diameter shaft, 5/8" long FMS. Screwdriver slot and short knurl.
TM3	1/4" diameter shaft, 1" long FMS. Screwdriver slot and short knurl.
TM4	1/4" diameter insulated shaft, 1 1/2" long FMS. Slotted and knurled full length. Not used with switches.
TM5	Knobmaster shaft, 2" long FMS. Knurled, grooved and flatted.
TM6	Special rounded and slotted shaft for G.E. 1/2" long FMS.
TM7	Special rounded and slotted shaft for G.E. 3/8" long FMS.
TM8	3/8" diameter shaft 2" long FMS. Flatted and grooved.
TM9	Reverse tab mount kit nylon shaft, 1 1/2" FMS. 1/4" dia., slotted and knurled.
TM10	Tab mount kit nylon shaft, 1 3/4" FMS. 3/8" dia., flatted full length.

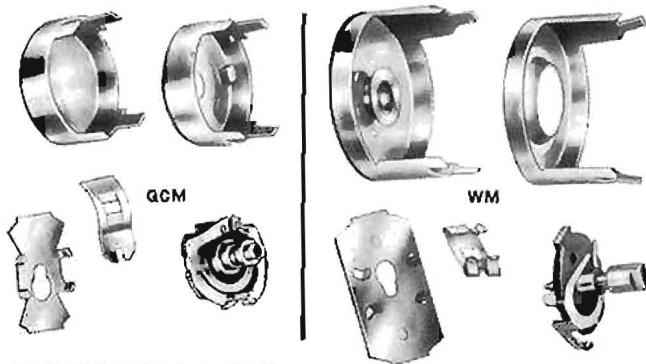

## MULTISECTION KITS

These kits provide parts needed to assemble desired Base-Element into a Multisection or rear control section. Permits assembly of dual, triple or quadruple section controls. Each kit contains internal shaft contactor assembly, front and rear covers, coupling plate and section coupler. Close-coupled construction provides minimum depth behind panel.

Stock No.	Description
QCM	Multisection Kit for Type Q. Specially designed for critical requirements of stereo controls. Will operate rotary power switches.
WM	Multisection Kit for Type 4W. Will not operate power switches.



## SPECIAL BUSHINGS

Stock No.	Description
S1	Sleeve Bushing—attaches to 3/8"-32 Bushing.
S2	Bearing Bushing—attaches to 3/8"-32 Bushing.
S3	Spacer Bushing—attaches to 3/8"-32 Bushing. Sets control 1" behind panel.
S4	Universal 1/2" diameter Bushing—Type Q only. 1 1/2" FMS.
S5	Universal 1/2" diameter Bushing—attaches to 3/8"-32 Bushing. 2 1/4" FMS.

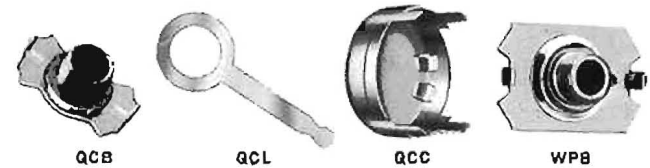

## Q/4W CONTROL PARTS

These parts facilitate assembly of many varied controls using desired shafts and base elements.

Stock No.	Description
QCB	Type Q Bushing. 3/8"-32 thread. 1/4" long FMS. For single controls.
QCB-1	Type Q Bushing. 3/8"-32 thread. 3/8" long FMS. For single controls.
QCB-2	Type Q Bushing. 3/8"-32 thread. 1/2" long FMS. For single controls.
QCB-3	Type Q Locking Bushing. 3/8"-32 thread. 3/8" FMS.
QCB-4	Type Q Bushing. 3/8"-32 thread. 1 3/4" FMS. For single controls.
QCB-5A	Type Q Bushing. 3/8"-32 thread. 2" FMS. For concentric dual controls.
QCB-6	Universal 1/2" Diameter Bushing. 1" FMS, attaches to 3/8"-32 Bushings. Can be used as L and T Pad Bushing extender.
QCC	Type Q Cover. For plain or tapped controls.
QCL	Grounding Lug for 3/8"-32 Bushing. Lug length 1 3/4" from hole center.
QCN	Mounting Nut for 3/8"-32 thread.
QCP	Printed circuit bracket w/nut.
WPB	Type 4W Bushing. 3/8"-32 thread. 1/4" long FMS.
WPC	Type 4W Cover.



## EXTENSION SHAFTS & COUPLERS

Stock No.	Description
441	Extension Shaft—4" x 1/4" with 1/2" flat.
442	Extension Shaft—4" x 1/4" with 3/8" flat.
443	Extension Shaft—4" x 3/8" with 1/4" flat.
444	Extension Shaft—8" x 1/4" with 3/8" flat for 4".
C3	Shaft Coupler—couples 3/8" shafts; insert allows coupling of 1/4" shaft to 3/8" shaft.

# CONCENTRIKIT TYPE Q & 4W PARTS



## HARDWARE FOR CONCENTRIKIT

Stock No.	Description
KA1	Knob Adapter. Fits rear section shaft to knob requirements of over-size shaft. Converts .187" diameter shaft to .202" diameter.
N1	Mounting Nut for 3/8" Bushings (3/8" across flats).
N2	Mounting Nut for 1/2" Bushings (5/8" across flats).
N3	Mounting Nut for 1/2" Bushings (5/8" across flats).
N4	Mounting Nut for 3/8" Bushings (1/2" across flats).
R2	Concentrikit.
R3	Q Concentric Duals.
R4	WP Concentric Duals.
R5	Ground Plate Tab Concentric Dual.
R6	Retainers as supplied in K16, K17 and K18 Kits.
R7	Shaft retainer for 1/4" diameter shafts. Replaces R1.

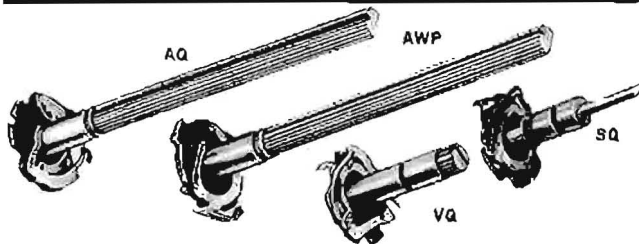

## SINGLE CONTROL SHAFTS

Using control parts listed on page 6, these shafts will assemble many variations of Types Q and 4W controls. Individually boxed with R7 retainer (except TQ).

Stock No.	Description
AQ	Knobmaster shaft, 1/4" diameter, 3" long FMS. Flatted, grooved and knurled full length. Fits knobs requiring flatted or knurled shaft. Uses QCB Bushing. For Type Q.
AQ-5	Same as AQ but 5" long FMS. For Type Q. (Bushing included.)
AWP	Same as AQ but for Type WPK control.
AWP-5	Same as AWP but 5" long FMS.
JQ	3/8" diameter shaft, 4 1/8" long FMS. Flatted .105" full length. Uses QCB Bushing. For Type Q.
NQ	3/8" diameter shaft, 4" long FMS. Flatted and grooved full length. Uses QCB Bushing. For Type Q.
PQ	1/4" diameter shaft, 3" long FMS. Full round. May be used with 1/4" or 3/8" long bushings. (3/8" long bushing included.) For Type Q.
PWP	Same as PQ but for Type WP control.
RQ	1/2" diameter shaft, 1/2" long FMS. Screwdriver slotted. Used with 3/8" long bushing only (included). For Type Q.
SQ	1/4" diameter shaft, 3/4" long FMS. Screwdriver slotted with short knurl. Uses QCB Bushing. For Type Q.
SWP	Same as SQ but for Type WPS. Uses WPB Bushing.
TQ	1/4" diameter shaft, 3" long FMS. Insulated, full round. Cannot be used with switch. Uses QCB, QCB-1, QCB-2. For Type Q.
VQ	1/4" diameter shaft, 1 1/2" long FMS. Tongued end 3/4" wide by 1/4" long by .050" thick. Uses QCB Bushing. For Type Q.
WQ	1/4" diameter shaft, 1" long FMS. Tongued end 1/4" wide by 1/2" long by .062" thick. Uses QCB Bushing. For Type Q.

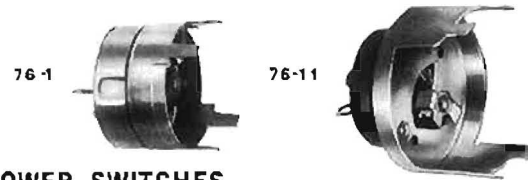

## POWER SWITCHES

Easily attached to Type Q or Type 4W controls. Stock No. 76-5 supplied for replacement only. For attachment of this pull-push switch to controls, use SK7 or SK8 Kit below with desired Base-Element.

Stock No.	Description
76-1	S.P.S.T.—Rotary type for Type Q.
76-2	D.P.S.T.—Rotary type for Type Q
76-4	S.P.O.T.—Rotary type for Type Q. Used also as "make-one, break-one" for spot-killer switch in TV.
76-5	S.P.S.T.—Pull-push type for Type Q.
76-11	S.P.S.T.—Rotary type for Types WP, WPK, WPRL, WPS.
76-12	D.P.S.T.—Rotary type for Types WP, WPK, WPRL, WPS.

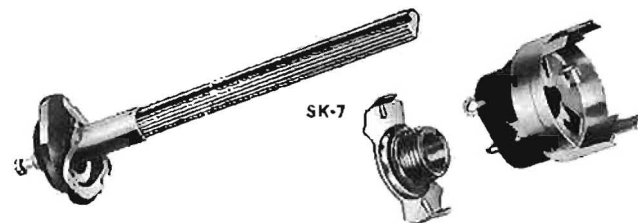
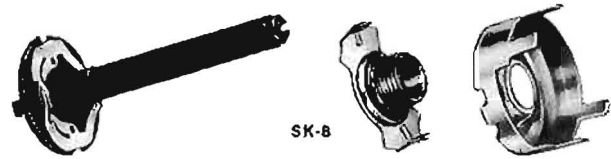

## SHAFT KITS FOR BUSHING MOUNTED CONTROLS

Package of parts for assembly of specific standard or special control type. Includes shaft, bushing and cover. Add desired Base-Element.

Stock No.	Description
SK1	Assembles Q Control with Knobmaster Shaft.
SK2	Assembles Q Control with RQ Shaft.
SK3	Assembles Q Control with SQ Shaft.
SK4	Assembles WPK Control.
SK5	Assembles WPS Control.
SK6	Assembles Q Control with Insulated Shaft.
SK7	Assembles Q Control with Knobmaster Shaft and 76-5 Pull-push Switch (Switch included). Shaft is 3" FMS.
SK8	Assembles Q Control with 3/8" diameter universal shaft and 76-5 Pull-push Switch (Switch included). Shaft is 3 1/2" FMS.
SK9	Assembles Q Control with 3/8" diameter universal shaft. 3 1/2" FMS.



# CONCENTRIKIT FOR CONCENTRIC DUALS



K-2



K-16

## CONCENTRIKITS FOR CONCENTRIC DUALS

Broadest replacement coverage of concentric dual controls for TV, radio and auto sets is provided by CONCENTRIKIT—the unique control parts system. Wide selection of exact duplicate shafts and bushings eliminates cutting, filing and slotting. The CONCENTRIKITS are packaged groups of parts common to specific control types. Base-Elements are listed on pages 2, 3 and 5. Specifications for nearly 2000 Exact Duplicate Controls included in Howard W. Sams "REPLACEMENT GUIDE FOR TV AND AUTO RADIO CONTROLS."

### TONE SWITCHES

Special tone switch Base-Elements for use in panel section of auto radio controls. Packed with detent-type panel cover.

Stock No.	Description
BS1	4 Position Tone Switch for Ford.
BS2	4 Position Tone Switch for Delco.
BS3	3 Position Tone Switch for Philco.
BS4	4 Position Tone Switch for Delco.
BS5	4 Position Tone Switch for Lincoln and Mercury.

### CONCENTRIKITS

Common parts for various types of concentric dual controls. Used with specific exact duplicate shafts and Base-Elements as specified in Howard W. Sams Replacement Control Guide, RGC.

Concentrikit	Panel Section	Rear Section	Bushing Size
K2*	C	C	3/8" x 3/8"
K3	W	W	3/4" x 3/8"
K4*	C	C	3/8" x 3/4"
K5*	C	C	3/8" x 1/4"
K6	C	C	3/8" x 3/8"
K7	C	C	3/8" x 3/4"
K8	TS	C	None
K9	C	C	None
K10	W	W	3/8" x 3/8"
K11	W	W	3/8" x 1/4"
K12	C	W	3/8" x 3/8"
K13	W	W	3/8" x 1/4"
K14	W	W	3/8" x 3/4"
K15	C	C	3/8" x 1/4"
K16**	C	C	3/8" x 3/8"
K17**	C	C	3/8" x 3/4"
K18**	C	C	3/8" x 1/4"

\* Spaced construction. All others close-coupled.  
 \*\* 76-5 Pull-push Switch included.  
 C—Carbon. W—Wire. TS—Tone Switch.

## EXACT DUPLICATE SHAFTS

OUTER SHAFT SPECIFICATIONS			
Shaft Type	Slot Width-Depth	Flat Length	Base-Element
P1**	1/8" x 3/8"	17/32"	Q
P2**	1/8" x 1/2"	17/32"	Q
P3	1/8" x 3/8"	17/32"	W
P4	1/8" x 3/8"	3/4"	W
P5	1/8" x 3/8"	17/32"	W
P6**	1/8" x 3/8"	17/32"	Q
P7**	.120" x 3/8"	17/32"	Q
P8	*	*	W
P9**	*	*	Q
P10**	1/8" x 7/16"	17/32"	Q
P11**	3/4" x 1/16"	—	Q
P12**	1/8" x 3/16"	—	Q
P13	1/8" x 1/4"	—	Q
P14	1/8" x 3/16"	—	Q
P15	1/8" x 1/4"	—	TS
P16	.132" x 3/16"	—	Q
P17	1/8" x 3/8"	5/8"	Q
P18	3/4" x 1/16"	—	W
P19	3/4" x 1/16"	*	Q
P20	—	*	Q
P21	1/8" x 7/16"	5/8"	Q
P22	1/8" x 1/2"	7/8"	Q
P23	1/8" x 19/32"	—	Q
P24***	—	17/32"	Q
P25***	—	17/32"	Q

\* Knurled Band 1/8" wide.  
 \*\* Spaced construction. All others close-coupled.  
 \*\*\* .250" diameter.

INNER SHAFT SPECIFICATIONS				
Shaft Type	Dia.	Slot Width-Depth	Flat Length	Base-Element
R1	.187"	1/16" x 1/2"	1/2"	Q
R2	.202"	1/16" x 1/2"	1/2"	Q
R3	.190"	Split Knurl	—	Q
R4	.180"	Round and Slotted	—	Q
R5	.187"	Rear Extension	—	Q
R6	.202"	Rear Extension	—	Q
R7	.189"	Split Knurl	—	Q
R8	.187"	1/16" x 1/2"	1/2"	W
R9	.187"	1/16" x 1/2"	5/8"	Q
R10	.187"	1/8" Wide Knurl	—	W
R11	.187"	1/8" Wide Knurl	—	Q
R12	.202"	3/32" Wide Knurl	—	Q
R13	.180"	5/8" Deep Slot	—	Q
R14	.202"	1/16" x 1/2"	5/8"	Q
R15	.202"	3/64" x 1/16"	—	Q
R16	.187"	1/16" x 1/2"	25/32"	Q
R17	.202"	1/16" x 1/2"	11/16"	Q
R18	.202"	1/16" x 1/2"	1/2"	W
R19	.202"	3/4" x 1/16"	—	W
R20	.187"	3/16" x 1/16"	—	Q
R21	.180"	1/16" x 5/8"	—	Q
R22	.202"	Rear Extension	—	W
R23*	.187"	—	17/32"	Q
R24*	.187"	1/16" x 1/2"	—	Q
R25*	.187"	—	1/2"	Q
R26	.187"	1/16" x 5/8"	25/32"	Q

\* Used with Pull-push Switch.

# CONCENTRIKIT EXACT DUPLICATE SHAFT SPECIFICATIONS



## EXACT DUPLICATE SHAFTS

Stock numbers and corresponding lengths are listed on these pages. In general, the last three numbers of the stock number indicates shaft length from control mounting face (not end of bushing) to end of shaft. Of the last three numbers, the first indicates number of inches and the second and third number indicates the number of 32nds. For Stock No. P1-210, length is 21<sup>3</sup>/<sub>32</sub>" or 2<sup>1</sup>/<sub>16</sub>". For inner shafts employed with K3 CONCENTRIKIT, subtract <sup>3</sup>/<sub>32</sub>" from dimension indicated by stock number.

There is an IRC Exact Duplicate Shaft available for nearly every concentric dual control. These Outer and Inner Shafts require no modification. Shaft lengths are held within close limits to original shaft lengths. Careful attention is given to end trims for fit to original knobs. The specifications on this page provide dimensions and use.

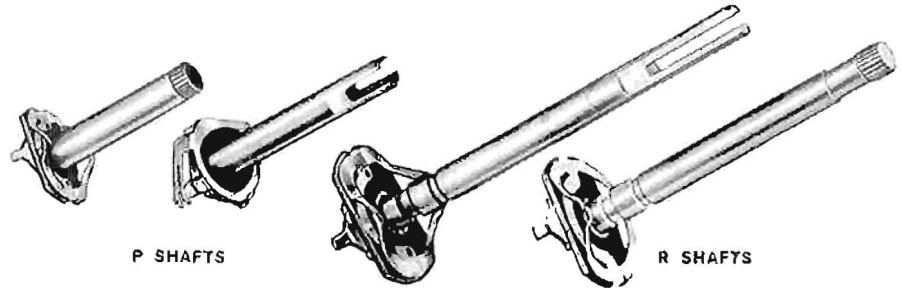

### OUTER SHAFTS

Stock No.	Shft. Lgth.	Stock No.	Shft. Lgth.	Stock No.	Shft. Lgth.	Stock No.	Shft. Lgth.	Stock No.	Shft. Lgth.	Stock No.	Shft. Lgth.	Stock No.	Shft. Lgth.
P1-017	1 <sup>1</sup> / <sub>2</sub> "	P1-306	3 <sup>3</sup> / <sub>4</sub> "	P3-129	1 <sup>1</sup> / <sub>2</sub> "	P7-222	2 <sup>1</sup> / <sub>4</sub> "	P13-122	1 <sup>1</sup> / <sub>4</sub> "	P15-114	1 <sup>1</sup> / <sub>4</sub> "	P18-015	1 <sup>1</sup> / <sub>2</sub> "
P1-020	5 <sup>8</sup> / <sub>16</sub> "	P1-308	3 <sup>1</sup> / <sub>2</sub> "	P3-131	1 <sup>3</sup> / <sub>4</sub> "	P8-016	2 <sup>1</sup> / <sub>8</sub> "	P13-128	1 <sup>7</sup> / <sub>8</sub> "	P15-120	1 <sup>5</sup> / <sub>8</sub> "	P18-018	3 <sup>1</sup> / <sub>4</sub> "
P1-024	3 <sup>4</sup> / <sub>8</sub> "	P1-310	3 <sup>5</sup> / <sub>8</sub> "	P3-203	2 <sup>3</sup> / <sub>8</sub> "	P8-020	5 <sup>8</sup> / <sub>16</sub> "	P13-200	2"	P15-122	1 <sup>5</sup> / <sub>8</sub> "	P19-012	3 <sup>1</sup> / <sub>2</sub> "
P1-028	7 <sup>8</sup> / <sub>16</sub> "	P1-314	3 <sup>1</sup> / <sub>2</sub> "	P3-208	2 <sup>1</sup> / <sub>4</sub> "	P8-100	1"	P13-210	2 <sup>1</sup> / <sub>4</sub> "	P15-130	1 <sup>1</sup> / <sub>2</sub> "	P19-016	1 <sup>1</sup> / <sub>2</sub> "
P1-030	1 <sup>1</sup> / <sub>4</sub> "	P1-317	3 <sup>1</sup> / <sub>2</sub> "	P3-210	2 <sup>1</sup> / <sub>4</sub> "	P8-106	1 <sup>1</sup> / <sub>4</sub> "	P13-214	2 <sup>1</sup> / <sub>4</sub> "	P15-200	2"	P20-101	1 <sup>1</sup> / <sub>2</sub> "
P1-102	1 <sup>1</sup> / <sub>4</sub> "	P1-320	3 <sup>5</sup> / <sub>8</sub> "	P3-212	2 <sup>3</sup> / <sub>8</sub> "	P8-424	4 <sup>3</sup> / <sub>8</sub> "	P13-217	2 <sup>1</sup> / <sub>2</sub> "	P15-204	2 <sup>1</sup> / <sub>8</sub> "	P20-104	1 <sup>1</sup> / <sub>4</sub> "
P1-106	1 <sup>1</sup> / <sub>2</sub> "	P1-325	3 <sup>1</sup> / <sub>2</sub> "	P3-214	2 <sup>1</sup> / <sub>4</sub> "	P9-018	1 <sup>1</sup> / <sub>2</sub> "	P14-014	1 <sup>1</sup> / <sub>2</sub> "	P15-206	2 <sup>1</sup> / <sub>8</sub> "	P20-212	2 <sup>3</sup> / <sub>8</sub> "
P1-109	1 <sup>1</sup> / <sub>2</sub> "	P1-400	4"	P3-217	2 <sup>1</sup> / <sub>4</sub> "	P9-021	1 <sup>1</sup> / <sub>2</sub> "	P14-016	1 <sup>1</sup> / <sub>2</sub> "	P15-218	2 <sup>1</sup> / <sub>8</sub> "	P21-029	2 <sup>1</sup> / <sub>8</sub> "
P1-112	3 <sup>8</sup> / <sub>16</sub> "	P1-405	4 <sup>1</sup> / <sub>8</sub> "	P3-223	2 <sup>3</sup> / <sub>8</sub> "	P9-101	1 <sup>1</sup> / <sub>2</sub> "	P14-019	1 <sup>1</sup> / <sub>2</sub> "	P16-023	3 <sup>8</sup> / <sub>16</sub> "	P22-015	1 <sup>1</sup> / <sub>2</sub> "
P1-114	1 <sup>1</sup> / <sub>2</sub> "	P2-031	1 <sup>1</sup> / <sub>2</sub> "	P3-226	2 <sup>1</sup> / <sub>4</sub> "	P9-104	1 <sup>1</sup> / <sub>2</sub> "	P14-024	1 <sup>1</sup> / <sub>2</sub> "	P16-027	3 <sup>8</sup> / <sub>16</sub> "	P22-021	1 <sup>1</sup> / <sub>2</sub> "
P1-116	1 <sup>1</sup> / <sub>2</sub> "	P2-116	1 <sup>1</sup> / <sub>2</sub> "	P3-400	4"	P9-112	1 <sup>3</sup> / <sub>8</sub> "	P14-026	1 <sup>1</sup> / <sub>2</sub> "	P17-024	3 <sup>8</sup> / <sub>16</sub> "	P22-027	1 <sup>1</sup> / <sub>2</sub> "
P1-118	1 <sup>1</sup> / <sub>2</sub> "	P2-118	1 <sup>1</sup> / <sub>2</sub> "	P3-405	4 <sup>1</sup> / <sub>8</sub> "	P9-116	1 <sup>1</sup> / <sub>2</sub> "	P14-029	1 <sup>1</sup> / <sub>2</sub> "	P17-028	3 <sup>8</sup> / <sub>16</sub> "	P22-100	1 <sup>1</sup> / <sub>2</sub> "
P1-121	1 <sup>1</sup> / <sub>2</sub> "	P2-128	1 <sup>7</sup> / <sub>8</sub> "	P4-115	1 <sup>1</sup> / <sub>2</sub> "	P9-124	1 <sup>3</sup> / <sub>4</sub> "	P14-102	1 <sup>1</sup> / <sub>4</sub> "	P17-031	3 <sup>1</sup> / <sub>4</sub> "	P22-103	1 <sup>1</sup> / <sub>2</sub> "
P1-123	1 <sup>1</sup> / <sub>2</sub> "	P2-200	2"	P4-121	1 <sup>1</sup> / <sub>2</sub> "	P9-128	1 <sup>7</sup> / <sub>8</sub> "	P14-112	1 <sup>3</sup> / <sub>8</sub> "	P17-102	1 <sup>1</sup> / <sub>2</sub> "	P22-109	1 <sup>1</sup> / <sub>2</sub> "
P1-126	1 <sup>1</sup> / <sub>2</sub> "	P2-209	2 <sup>3</sup> / <sub>8</sub> "	P4-124	1 <sup>3</sup> / <sub>4</sub> "	P9-209	2 <sup>3</sup> / <sub>8</sub> "	P14-118	1 <sup>1</sup> / <sub>4</sub> "	P17-105	1 <sup>1</sup> / <sub>2</sub> "	P22-115	1 <sup>1</sup> / <sub>2</sub> "
P1-128	1 <sup>7</sup> / <sub>8</sub> "	P2-214	2 <sup>1</sup> / <sub>4</sub> "	P5-206	2 <sup>1</sup> / <sub>4</sub> "	P9-212	2 <sup>3</sup> / <sub>8</sub> "	P14-121	1 <sup>1</sup> / <sub>4</sub> "	P17-108	1 <sup>1</sup> / <sub>4</sub> "	P22-121	1 <sup>1</sup> / <sub>2</sub> "
P1-200	2"	P2-218	2 <sup>1</sup> / <sub>4</sub> "	P6-028	7 <sup>8</sup> / <sub>16</sub> "	P10-110	1 <sup>1</sup> / <sub>4</sub> "	P14-125	1 <sup>1</sup> / <sub>2</sub> "	P17-112	1 <sup>3</sup> / <sub>8</sub> "	P22-203	2 <sup>3</sup> / <sub>8</sub> "
P1-204	2 <sup>1</sup> / <sub>8</sub> "	P2-222	2 <sup>1</sup> / <sub>4</sub> "	P6-102	1 <sup>1</sup> / <sub>4</sub> "	P10-225	2 <sup>3</sup> / <sub>8</sub> "	P14-130	1 <sup>1</sup> / <sub>4</sub> "	P17-115	1 <sup>1</sup> / <sub>4</sub> "	P22-312	3 <sup>1</sup> / <sub>8</sub> "
P1-206	2 <sup>1</sup> / <sub>8</sub> "	P2-226	2 <sup>1</sup> / <sub>4</sub> "	P6-112	1 <sup>3</sup> / <sub>8</sub> "	P10-227	2 <sup>1</sup> / <sub>4</sub> "	P14-202	2 <sup>1</sup> / <sub>4</sub> "	P17-118	1 <sup>1</sup> / <sub>4</sub> "	P22-315	3 <sup>1</sup> / <sub>8</sub> "
P1-210	2 <sup>1</sup> / <sub>8</sub> "	P3-028	7 <sup>8</sup> / <sub>16</sub> "	P6-122	1 <sup>1</sup> / <sub>4</sub> "	P10-308	3 <sup>1</sup> / <sub>4</sub> "	P14-204	2 <sup>1</sup> / <sub>8</sub> "	P17-120	1 <sup>1</sup> / <sub>4</sub> "	P23-100	1"
P1-212	2 <sup>1</sup> / <sub>8</sub> "	P3-100	1"	P6-125	1 <sup>3</sup> / <sub>8</sub> "	P11-018	1 <sup>1</sup> / <sub>4</sub> "	P14-206	2 <sup>1</sup> / <sub>8</sub> "	P17-123	1 <sup>1</sup> / <sub>4</sub> "	P23-103	1 <sup>1</sup> / <sub>4</sub> "
P1-216	2 <sup>1</sup> / <sub>2</sub> "	P3-104	1 <sup>1</sup> / <sub>8</sub> "	P6-130	1 <sup>1</sup> / <sub>2</sub> "	P11-024	3 <sup>8</sup> / <sub>16</sub> "	P14-208	2 <sup>1</sup> / <sub>4</sub> "	P17-126	1 <sup>1</sup> / <sub>4</sub> "	P23-112	1 <sup>1</sup> / <sub>4</sub> "
P1-220	2 <sup>5</sup> / <sub>8</sub> "	P3-106	1 <sup>1</sup> / <sub>8</sub> "	P6-200	2"	P11-102	1 <sup>1</sup> / <sub>4</sub> "	P14-211	2 <sup>1</sup> / <sub>4</sub> "	P17-129	1 <sup>1</sup> / <sub>4</sub> "	P23-130	1 <sup>1</sup> / <sub>4</sub> "
P1-222	2 <sup>1</sup> / <sub>4</sub> "	P3-111	1 <sup>5</sup> / <sub>8</sub> "	P6-202	2 <sup>1</sup> / <sub>4</sub> "	P12-122	1 <sup>1</sup> / <sub>4</sub> "	P14-214	2 <sup>1</sup> / <sub>4</sub> "	P17-204	2 <sup>1</sup> / <sub>8</sub> "	P24-030	1 <sup>1</sup> / <sub>4</sub> "
P1-224	2 <sup>3</sup> / <sub>8</sub> "	P3-114	1 <sup>1</sup> / <sub>2</sub> "	P6-211	2 <sup>1</sup> / <sub>4</sub> "	P12-204	2 <sup>1</sup> / <sub>8</sub> "	P14-303	3 <sup>1</sup> / <sub>8</sub> "	P17-208	2 <sup>1</sup> / <sub>4</sub> "	P24-103	1 <sup>1</sup> / <sub>4</sub> "
P1-226	2 <sup>1</sup> / <sub>4</sub> "	P3-116	1 <sup>1</sup> / <sub>2</sub> "	P6-218	2 <sup>1</sup> / <sub>4</sub> "	P13-022	1 <sup>1</sup> / <sub>4</sub> "	P15-019	1 <sup>1</sup> / <sub>4</sub> "	P17-214	2 <sup>1</sup> / <sub>4</sub> "	P25-121	1 <sup>1</sup> / <sub>4</sub> "
P1-229	2 <sup>3</sup> / <sub>8</sub> "	P3-118	1 <sup>1</sup> / <sub>2</sub> "	P6-224	2 <sup>3</sup> / <sub>4</sub> "	P13-104	1 <sup>1</sup> / <sub>8</sub> "	P15-026	1 <sup>1</sup> / <sub>4</sub> "	P17-224	2 <sup>3</sup> / <sub>8</sub> "		
P1-300	3 <sup>1</sup> / <sub>8</sub> "	P3-121	1 <sup>5</sup> / <sub>8</sub> "	P6-302	3 <sup>1</sup> / <sub>8</sub> "	P13-113	1 <sup>1</sup> / <sub>4</sub> "	P15-102	1 <sup>1</sup> / <sub>4</sub> "	P17-300	3"		
P1-302	3 <sup>1</sup> / <sub>8</sub> "	P3-123	1 <sup>5</sup> / <sub>8</sub> "	P7-109	1 <sup>1</sup> / <sub>2</sub> "	P13-116	1 <sup>1</sup> / <sub>4</sub> "	P15-106	1 <sup>1</sup> / <sub>4</sub> "	P17-310	3 <sup>1</sup> / <sub>4</sub> "		
P1-304	3 <sup>1</sup> / <sub>8</sub> "	P3-127	1 <sup>5</sup> / <sub>8</sub> "	P7-206	2 <sup>1</sup> / <sub>4</sub> "	P13-118	1 <sup>1</sup> / <sub>4</sub> "	P15-112	1 <sup>1</sup> / <sub>8</sub> "	P17-316	3 <sup>1</sup> / <sub>2</sub> "		

### INNER SHAFTS

Stock No.	Shft. Lgth.	Stock No.	Shft. Lgth.	Stock No.	Shft. Lgth.	Stock No.	Shft. Lgth.	Stock No.	Shft. Lgth.	Stock No.	Shft. Lgth.	Stock No.	Shft. Lgth.
R1-024	3 <sup>4</sup> / <sub>8</sub> "	R1-304	3 <sup>1</sup> / <sub>4</sub> "	R2-230	2 <sup>1</sup> / <sub>8</sub> "	R7-212	2 <sup>3</sup> / <sub>8</sub> "	R12-119	1 <sup>1</sup> / <sub>4</sub> "	R16-313	3 <sup>1</sup> / <sub>4</sub> "	R23-312	3 <sup>3</sup> / <sub>8</sub> "
R1-028	7 <sup>8</sup> / <sub>16</sub> "	R1-308	3 <sup>1</sup> / <sub>4</sub> "	R2-300	3"	R7-229	2 <sup>3</sup> / <sub>8</sub> "	R12-122	1 <sup>1</sup> / <sub>4</sub> "	R17-203	2 <sup>3</sup> / <sub>8</sub> "	R24-109	1 <sup>1</sup> / <sub>4</sub> "
R1-100	1"	R1-312	3 <sup>5</sup> / <sub>8</sub> "	R2-306	3 <sup>1</sup> / <sub>2</sub> "	R8-213	2 <sup>1</sup> / <sub>2</sub> "	R12-129	1 <sup>3</sup> / <sub>8</sub> "	R17-206	2 <sup>1</sup> / <sub>8</sub> "	R24-115	1 <sup>1</sup> / <sub>2</sub> "
R1-103	1 <sup>1</sup> / <sub>4</sub> "	R1-316	3 <sup>1</sup> / <sub>2</sub> "	R2-308	3 <sup>1</sup> / <sub>4</sub> "	R9-110	1 <sup>1</sup> / <sub>4</sub> "	R12-131	1 <sup>1</sup> / <sub>4</sub> "	R17-216	2 <sup>1</sup> / <sub>2</sub> "	R24-124	1 <sup>3</sup> / <sub>4</sub> "
R1-105	1 <sup>1</sup> / <sub>4</sub> "	R1-323	3 <sup>5</sup> / <sub>8</sub> "	R2-310	3 <sup>1</sup> / <sub>4</sub> "	R9-112	1 <sup>3</sup> / <sub>8</sub> "	R12-206	2 <sup>1</sup> / <sub>4</sub> "	R18-200	2"	R24-127	1 <sup>1</sup> / <sub>4</sub> "
R1-108	1 <sup>1</sup> / <sub>4</sub> "	R1-326	3 <sup>1</sup> / <sub>2</sub> "	R2-312	3 <sup>1</sup> / <sub>4</sub> "	R9-115	1 <sup>1</sup> / <sub>2</sub> "	R13-316	3 <sup>1</sup> / <sub>2</sub> "	R19-011	1 <sup>1</sup> / <sub>4</sub> "	R24-204	2 <sup>1</sup> / <sub>4</sub> "
R1-111	1 <sup>1</sup> / <sub>4</sub> "	R1-417	4 <sup>1</sup> / <sub>2</sub> "	R2-314	3 <sup>1</sup> / <sub>4</sub> "	R9-202	2 <sup>1</sup> / <sub>4</sub> "	R13-331	3 <sup>1</sup> / <sub>2</sub> "	R19-014	2 <sup>1</sup> / <sub>4</sub> "	R24-208	2 <sup>1</sup> / <sub>4</sub> "
R1-113	1 <sup>1</sup> / <sub>2</sub> "	R1-420	4 <sup>5</sup> / <sub>8</sub> "	R2-318	3 <sup>1</sup> / <sub>4</sub> "	R9-205	2 <sup>3</sup> / <sub>8</sub> "	R14-116	1 <sup>1</sup> / <sub>2</sub> "	R20-208	2 <sup>1</sup> / <sub>4</sub> "	R24-216	2 <sup>1</sup> / <sub>2</sub> "
R1-115	1 <sup>1</sup> / <sub>2</sub> "	R2-028	7 <sup>8</sup> / <sub>16</sub> "	R2-322	3 <sup>1</sup> / <sub>4</sub> "	R9-208	2 <sup>1</sup> / <sub>4</sub> "	R14-128	1 <sup>7</sup> / <sub>8</sub> "	R20-213	2 <sup>1</sup> / <sub>4</sub> "	R24-224	2 <sup>3</sup> / <sub>8</sub> "
R1-118	1 <sup>1</sup> / <sub>2</sub> "	R2-103	1 <sup>3</sup> / <sub>8</sub> "	R2-329	3 <sup>1</sup> / <sub>4</sub> "	R9-211	2 <sup>1</sup> / <sub>4</sub> "	R14-204	2 <sup>1</sup> / <sub>8</sub> "	R21-201	2 <sup>1</sup> / <sub>4</sub> "	R24-306	3 <sup>1</sup> / <sub>8</sub> "
R1-122	1 <sup>1</sup> / <sub>2</sub> "	R2-105	1 <sup>3</sup> / <sub>8</sub> "	R2-401	4 <sup>1</sup> / <sub>8</sub> "	R9-214	2 <sup>1</sup> / <sub>4</sub> "	R14-211	2 <sup>1</sup> / <sub>8</sub> "	R21-220	2 <sup>1</sup> / <sub>4</sub> "	R24-328	3 <sup>1</sup> / <sub>8</sub> "
R1-126	1 <sup>1</sup> / <sub>2</sub> "	R2-110	1 <sup>3</sup> / <sub>8</sub> "	R2-420	4 <sup>1</sup> / <sub>8</sub> "	R9-222	2 <sup>1</sup> / <sub>4</sub> "	R14-214	2 <sup>1</sup> / <sub>8</sub> "	R22-200	2"	R25-118	1 <sup>1</sup> / <sub>4</sub> "
R1-130	1 <sup>1</sup> / <sub>2</sub> "	R2-115	1 <sup>3</sup> / <sub>8</sub> "	R2-426	4 <sup>1</sup> / <sub>8</sub> "	R9-314	3 <sup>1</sup> / <sub>4</sub> "	R14-229	2 <sup>1</sup> / <sub>8</sub> "	R23-107	1 <sup>1</sup> / <sub>4</sub> "	R25-200	2"
R1-200	2"	R2-117	1 <sup>3</sup> / <sub>8</sub> "	R2-429	4 <sup>1</sup> / <sub>8</sub> "	R9-324	3 <sup>1</sup> / <sub>4</sub> "	R14-302	3 <sup>1</sup> / <sub>4</sub> "	R23-114	1 <sup>1</sup> / <sub>4</sub> "	R26-112	1 <sup>3</sup> / <sub>8</sub> "
R1-202	2 <sup>1</sup> / <sub>8</sub> "	R2-119	1 <sup>3</sup> / <sub>8</sub> "	R3-204	2 <sup>1</sup> / <sub>4</sub> "	R10-028	7 <sup>8</sup> / <sub>16</sub> "	R14-308	3 <sup>1</sup> / <sub>4</sub> "	R23-119	1 <sup>1</sup> / <sub>4</sub> "	R26-121	1 <sup>3</sup> / <sub>8</sub> "
R1-205	2 <sup>1</sup> / <sub>8</sub> "	R2-124	1 <sup>3</sup> / <sub>8</sub> "	R3-223	2 <sup>1</sup> / <sub>4</sub> "	R10-431	4 <sup>1</sup> / <sub>2</sub> "	R14-409	4 <sup>1</sup> / <sub>2</sub> "	R23-122	1 <sup>1</sup> / <sub>4</sub> "	R26-124	1 <sup>3</sup> / <sub>8</sub> "
R1-207	2 <sup>1</sup> / <sub>8</sub> "	R2-127	1 <sup>3</sup> / <sub>8</sub> "	R3-331	3 <sup>1</sup> / <sub>4</sub> "	R11-028	7 <sup>8</sup> / <sub>16</sub> "	R14-414	4 <sup>1</sup> / <sub>2</sub> "	R23-125	1 <sup>1</sup> / <sub>4</sub> "	R26-206	2 <sup>1</sup> / <sub>4</sub> "
R1-209	2 <sup>1</sup> / <sub>8</sub> "	R2-131	1 <sup>3</sup> / <sub>8</sub> "	R4-106	1 <sup>1</sup> / <sub>4</sub> "	R11-031	7 <sup>8</sup> / <sub>16</sub> "	R14-419	4 <sup>1</sup> / <sub>2</sub> "	R23-128	1 <sup>1</sup> / <sub>4</sub> "	R26-208	2 <sup>1</sup> / <sub>4</sub> "
R1-210	2 <sup>1</sup> / <sub>8</sub> "	R2-200	2"	R4-210	2 <sup>1</sup> / <sub>4</sub> "	R11-038	1 <sup>1</sup> / <sub>4</sub> "	R14-426	4 <sup>1</sup> / <sub>2</sub> "	R23-200	2"	R26-215	2 <sup>1</sup> / <sub>4</sub> "
R1-212	2 <sup>1</sup> / <sub>8</sub> "	R2-204	2 <sup>1</sup> / <sub>8</sub> "	R4-212	2 <sup>1</sup> / <sub>4</sub> "	R11-112	1 <sup>1</sup> / <sub>4</sub> "	R15-005	3 <sup>1</sup> / <sub>2</sub> "	R23-202	2 <sup>1</sup> / <sub>4</sub> "	R26-230	2 <sup>1</sup> / <sub>4</sub> "
R1-214	2 <sup>1</sup> / <sub>8</sub> "	R2-206	2 <sup>1</sup> / <sub>8</sub> "	R4-221	2 <sup>1</sup> / <sub>4</sub> "	R11-118	1 <sup>1</sup> / <sub>4</sub> "	R15-009	3 <sup>1</sup> / <sub>2</sub> "	R23-205	2 <sup>1</sup> / <sub>4</sub> "	R26-303	3 <sup>1</sup> / <sub>2</sub> "
R1-216	2 <sup>1</sup> / <sub>8</sub> "	R2-209	2 <sup>1</sup> / <sub>8</sub> "	R4-226	2 <sup>1</sup> / <sub>4</sub> "	R11-124	1 <sup>1</sup> / <sub>4</sub> "	R15-017	3 <sup>1</sup> / <sub>2</sub> "	R23-208	2 <sup>1</sup> / <sub>4</sub> "	R26-309	3 <sup>1</sup> / <sub>2</sub> "
R1-218	2 <sup>1</sup> / <sub>8</sub> "	R2-212	2 <sup>1</sup> / <sub>8</sub> "	R4-228	2 <sup>1</sup> / <sub>4</sub> "	R11-200	2"	R15-028	3 <sup>1</sup> / <sub>2</sub> "	R23-211	2 <sup>1</sup> / <sub>4</sub> "	R26-312	3 <sup>1</sup> / <sub>2</sub> "
R1-220	2 <sup>1</sup> / <sub>8</sub> "	R2-216	2 <sup>1</sup> / <sub>8</sub> "	R4-306	3 <sup>1</sup> / <sub>4</sub> "	R11-216	2 <sup>1</sup> / <sub>4</sub> "	R16-106	1 <sup>1</sup> / <sub>4</sub> "	R23-216	2 <sup>1</sup> / <sub>4</sub> "	R26-315	3 <sup>1</sup> / <sub>2</sub> "
R1-223	2 <sup>1</sup> / <sub>8</sub> "	R2-218	2 <sup>1</sup> / <sub>8</sub> "	R4-322	3 <sup>1</sup> / <sub>4</sub> "	R11-219	2 <sup>1</sup> / <sub>4</sub> "	R16-112	1 <sup>1</sup> / <sub>4</sub> "	R23-218	2 <sup>1</sup> / <sub>4</sub> "		
R1-226	2 <sup>1</sup> / <sub>8</sub> "	R2-220	2 <sup>1</sup> / <sub>8</sub> "	R5-215	2 <sup>1</sup> / <sub>4</sub> "	R12-026	1 <sup>1</sup> / <sub>4</sub> "	R16-118	1 <sup>1</sup> / <sub>4</sub> "	R23-			



# AUTO RADIO BUSHINGS & TAPER CHART

## EXACT DUPLICATE BUSHINGS FOR AUTO RADIOS

Stock No.	Dimensions	Type
S6	$\frac{7}{16} \times 1\frac{1}{16}$ "	Double-flat
S7	$\frac{7}{16} \times 1\frac{1}{32}$ "	Double-flat
S8	$\frac{7}{16} \times 1\frac{5}{16}$ "	Double-flat
S9	$\frac{7}{16} \times 1\frac{7}{8}$ "	Double-flat
S10	$\frac{1}{2} \times 0.2$ "	Single-flat
S11	$\frac{1}{2} \times \frac{3}{16}$ "	Single-flat
S12	$\frac{1}{2} \times 1\frac{5}{16}$ "	Single-flat
S13	$\frac{1}{2} \times 1$ "	Single-flat
S14	$\frac{1}{2} \times 1\frac{1}{4}$ "	Single-flat
S15	$\frac{1}{2} \times 1\frac{1}{2}$ "	Single-flat
S16	$\frac{1}{2} \times 1\frac{9}{16}$ "	Single-flat
S17	$\frac{1}{2} \times 1\frac{7}{8}$ "	Single-flat
S18	$\frac{1}{2} \times 2$ "	Single-flat
S19	$\frac{1}{2} \times 2\frac{1}{8}$ "	Single-flat
S20	$\frac{1}{2} \times 2\frac{1}{4}$ "	Single-flat
S21	$\frac{1}{2} \times 1\frac{1}{8}$ "	Notched
S22	$\frac{1}{2} \times 1\frac{3}{16}$ "	Notched
S23	$\frac{1}{2} \times 1\frac{1}{2}$ "	Notched
S24	$\frac{1}{2} \times 1\frac{3}{8}$ "	Notched
S25	$\frac{1}{2} \times 1\frac{1}{4}$ "	Notched
S26	$\frac{1}{2} \times 1\frac{1}{32}$ "	Notched
S27	$\frac{1}{2} \times 1\frac{1}{32}$ "	Notched
S28	$\frac{1}{2} \times 1\frac{3}{4}$ "	Notched
S29	$\frac{1}{2} \times 1\frac{13}{16}$ "	Notched
S30	$\frac{1}{2} \times 1\frac{7}{8}$ "	Notched
S31	$\frac{1}{2} \times 2$ "	Notched
S32	$\frac{1}{2} \times 2\frac{1}{8}$ "	Notched
S33	$\frac{3}{8} \times \frac{1}{4}$ "	—
S34	$\frac{3}{8} \times \frac{3}{8}$ "	—
S35	$\frac{1}{2} \times 1\frac{1}{2}$ "	Single-flat
S36	$\frac{1}{2} \times \frac{5}{8}$ "	Single-flat
S37	$\frac{1}{2} \times \frac{1}{2}$ "	Single-flat
S38	$\frac{1}{2} \times \frac{7}{32}$ "	Single-flat
S39	$\frac{1}{2} \times \frac{3}{4}$ "	Single-flat
S40	$\frac{1}{2} \times 1\frac{1}{16}$ "	Single-flat
S41	$\frac{1}{2} \times 1\frac{1}{16}$ "	Notched
S42	$\frac{1}{2} \times 1\frac{1}{16}$ "	Single-flat
S43	$\frac{1}{2} \times 1\frac{1}{8}$ "	Single-flat
S44	$\frac{3}{8} \times .590$ "	—
S45	$\frac{3}{8} \times 1\frac{1}{16}$ "	—
S46	$\frac{7}{16} \times \frac{5}{8}$ "	Double-flat
S47	$\frac{7}{16} \times 1\frac{1}{32}$ "	Double-flat
S48	$\frac{1}{2} \times \frac{3}{16}$ "	Single-flat
S49	$\frac{1}{2} \times 1$ "	Notched
S50	$\frac{1}{2} \times 1\frac{1}{16}$ "	Single-flat
S51	$\frac{7}{16} \times 1\frac{1}{4}$ "	Double-flat
S52	$\frac{3}{8} \times \frac{7}{8}$ "	—

## TAPERS

New numerical taper system assigns specific identification for each Control. Listing below shows new taper number and old taper designation.

NEW TAPER DESIGNATION	OLD TAPER DESIGNATION	USE
1, 2	A	For potentiometer or rheostat where uniform resistance change is required.
3	C	Left-hand logarithmic taper for audio circuit control.
4, 5, 23, 45	D, Q, P	Right-hand semi-logarithmic taper for use in contrast and picture control circuits in television. Taper 4 is also used for stereo tone and balance control.
6	S	Bass and treble tone control for Philco.
7, 39, 41	S	Bass and treble tone control for Philco—open-circuited at mid-point.
8, 9, 20, 27, 38	S	Tapped right-hand taper for contrast and picture control circuits in television.
10	S	Tapped left-hand taper for contrast and picture control circuits in television. Also used for audio compensation.
11, 22, 24, 26, 30, 31, 37, 40, 44, 47	H, S	Tapped left-hand logarithmic taper for audio level control for automatic bass compensation.
12	S	Left-hand taper tapped at 50% of total resistance for audio compensation.
13	S	Left-hand taper tapped at 10% of total resistance for audio compensation, for transistor circuits.
14, 21, 28, 29	S	Right-hand logarithmic taper tapped for contrast and picture control circuits in television.
15, 16, 17, 18, 19, 35, 36, 43, 46	S	Left-hand logarithmic taper with double taps for tone and loudness compensation.
32	S	Fader control.
33	S	Left-hand taper with two taps for contrast and picture control circuits in television.
34, 38, 48	S	Right-hand taper with two taps for contrast and picture control circuits in television.
—	L	Left-hand taper for use in focus circuits in television.
—	R	Right-hand logarithmic taper for use in contrast and picture control circuits in television.
—	S	Tapped right-hand taper for contrast and picture control circuits in television.
—	U	For potentiometer or rheostat where uniform resistance change is required.

# CONCENTRIKIT DEALER STOCKS



## HANDSOME STOCK CABINET

The same spacious stock cabinet is provided with either the No. 90 or No. 92 stocks. Permits ready conversion of Basic Stock to Expanded Stock. Sturdy two-shelf metal cabinet measures 17 $\frac{7}{8}$ " wide, 11 $\frac{1}{8}$ " deep and 9" high. Provides twelve large "see-thru" drawers with new locking divider feature. Drawers measure 11" deep, 4" wide and 2" high—956 cubic inches of stock space! All needed dividers are included. Both drawer front and bottom labels provide full location and identification data.

## EXTENSIVE VARIATION OF CONTROL TYPES

CONCENTRIKIT Dealer Control Stocks provide an extensive variation of single and concentric dual control types. Included are a wide selection of control mountings, shafts, and power switches with both carbon ( $\frac{1}{2}$  watt) and wire-wound (4 watts) front and rear sections. Control mountings include  $\frac{3}{8}$ ",  $\frac{7}{16}$ " and  $\frac{1}{2}$ " diameter bushings, tab mounting plates and printed circuit brackets. Shaft styles include  $\frac{1}{4}$ " and  $\frac{3}{16}$ " diameter universal shafts, screw-driver slotted and insulated shafts, rear adjustment feature and a large selection of exact duplicate shafts which require no cutting or modification

Rotary and pull-push power switches attach to either single or concentric dual styles. Concentric dual controls include carbon front and rear sections, wirewound front and rear sections and wirewound front sections with carbon rear sections. Carbon units are equipped with printed circuit terminals for universal use. Broad selection of resistance values and tapers. Replacement data, pricing information and full instructions included.

## CONCENTRIKIT DEALER CONTROL STOCKS

Most widely used control replacement system, the new CONCENTRIKIT stocks employ the unique adaptability of this true control parts system to provide top coverage of needed replacement controls. Parts included have been carefully selected for broadest combinations for TV, radio, auto sets and high-fidelity equipment. The exclusive features of CONCENTRIKIT afford a nearly endless variety of single and concentric dual controls.

Two specially planned dealer stocks are available. No. 90 is a Basic Stock of Concentrik kit parts. No. 92 is an Expanded Stock providing over three times the replacement coverage. Both stocks are housed in the same large metal cabinet with twelve "see-thru" drawers. Special labelling supplies quick location and identification of parts. No. 91 Conversion Stock changes the Basic Stock into the Expanded Stock.

## CONTENTS OF NEW DEALER CONCENTRIKIT STOCKS

DESCRIPTION	BASIC STOCK No. 90	CON-VERSION STOCK No. 91	EXPANDED STOCK No. 92
Carbon Base-Elements	25	22	47
Wirewound Base-Elements	—	6	6
Exact Duplicate Concentric Shafts	86	29	115
CONCENTRIKITS	9	5	14
Single Control Shaft Kits	14	8	22
Separate Insulated Shafts	—	2	2
Printed Circuit Bracket	1	—	1
Special Bushings	—	3	3
Power Switches (Rotary and Pull-Push)	8	8	16
Hardware Items	4	—	4
Replacement Manual	1	—	1
Instruction Package	1	—	1



# INDUSTRIAL Q CONTROLS

IRC ½ watt controls for industrial and commercial applications provide a wide selection of resistance values, tapers and shaft styles. Types PQ, RQ and RQL may be combined with Type M Multisections to provide broad variety of multiple-section controls.

## TYPE PQ

Control has full round ¼" shaft, extending approximately 3" from mounting face, and with ⅜" long bushing. ½ watt power rating, 500 volts maximum. It is available in 33 stock values.

## TYPE RQ

Control has a very short screwdriver slot shaft of ¼" diameter and approximately ½" long from mounting face, with ⅜" long bushing. ½ watt power rating. Supplied in 33 stock values.

Electrical rotation of these controls is the same with

or without power switches (See Type Q Accessories, pages 6 and 7). Special platings of metal parts provide excellent appearance. Resistance tolerance of all units is ± 10%.

## TYPE RQL

A 10% tolerance control with locking type bushing. Screwdriver slot shaft is ¼" diameter and approximately ½" long from mounting face, with a ⅜" split type bushing, and locking nut. Supplied in 26 stock values. ½ watt power rating.

## TYPE M MULTISECTIONS

IRC Type M Multisections are rear control sections which add to Types PQ, RQ, RQL or any Type Q control to provide multiple-section tandem controls. Supplied in 25 stock numbers as listed on opposite page. Resistance tolerance is ± 10%. See pages 6 and 7 for power switches and other accessories.

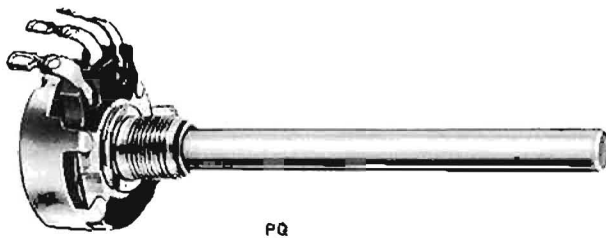

PQ



M



RQ with Multisections



RQ



RQL

## DIMENSIONS OF TYPE Q INDUSTRIAL CONTROLS

Dimension	PQ	RQ	RQL
A	¾"	¾"	¾"
B	⅝"	⅝"	⅝"
C	1 ¼"	1 ¼"	1 ¼"

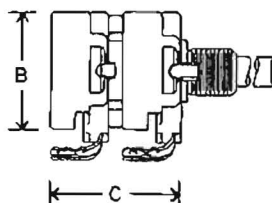
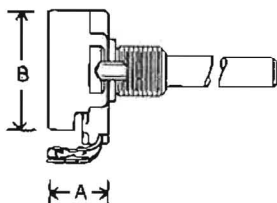

Ohms	Taper*	Type PQ	Type RQ	Type RQL	Multisections
500	1(A)	PQ11-103	RQ11-103	RQL11-103	M11-103
1,000	2(A)	PQ11-108	RQ11-108	RQL11-108	M11-108
2,000	2(A)	PQ11-110	RQ11-110	RQL11-110	M11-110
3,000	2(A)	PQ11-112	RQ11-112	RQL11-112	M11-112
5,000	2(A)	PQ11-114	RQ11-114	RQL11-114	M11-114
7,500	2(A)	PQ11-115	RQ11-115	—	—
10K	2(A)	PQ11-116	RQ11-116	RQL11-116	M11-116
10K	3(C)	PQ13-116	RQ13-116	—	—
10K	23(D)	PQ14-116	RQ14-116	—	—
10K	4(Q)	—	—	—	M17-116
20K	2(A)	PQ11-119	RQ11-119	RQL11-119	—
25K	2(A)	PQ11-120	RQ11-120	RQL11-120	M11-120
25K	23(D)	PQ14-120	RQ14-120	—	—
30K	2(A)	PQ11-121	RQ11-121	RQL11-121	M11-121
50K	2(A)	PQ11-123	RQ11-123	RQL11-123	M11-123
50K	3(C)	PQ13-123	RQ13-123	RQL13-123	—
50K	23(D)	PQ14-123	RQ14-123	—	—
100K	2(A)	PQ11-128	RQ11-128	RQL11-128	M11-128
100K	3(C)	PQ13-128	RQ13-128	—	M13-128
200K	2(A)	PQ11-129	RQ11-129	RQL11-129	—
250K	2(A)	PQ11-130	RQ11-130	RQL11-130	M11-130
250K	3(C)	PQ13-130	RQ13-130	RQL13-130	M13-130
500K	2(A)	PQ11-133	RQ11-133	RQL11-133	M11-133
500K	3(C)	PQ13-133	RQ13-133	RQL13-133	M13-133
1.0 Meg.	2(A)	PQ11-137	RQ11-137	RQL11-137	M11-137
1.0 Meg.	3(C)	PQ13-137	RQ13-137	RQL13-137	M13-137
1.5 Meg.	2(A)	PQ11-138	RQ11-138	RQL11-138	—
1.5 Meg.	3(C)	—	—	—	M13-138
2.0 Meg.	2(A)	PQ11-139	RQ11-139	RQL11-139	M11-139
2.0 Meg.	3(C)	PQ13-139	RQ13-139	RQL13-139	M13-139
2.5 Meg.	2(A)	PQ11-239	RQ11-239	RQL11-239	—
3.0 Meg.	2(A)	PQ11-140	RQ11-140	RQL11-140	—
3.0 Meg.	3(C)	PQ13-140	RQ13-140	—	M13-140
3.0 Meg.	4(Q)	—	—	—	M17-140
5.0 Meg.	2(A)	PQ11-141	RQ11-141	RQL11-141	M11-141
10.0 Meg.	2(A)	PQ11-143	RQ11-143	RQL11-143	M11-143

# INDUSTRIAL 4W CONTROLS

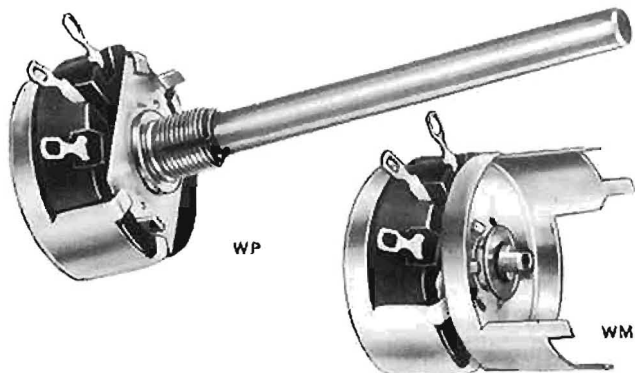

WP



WPRL

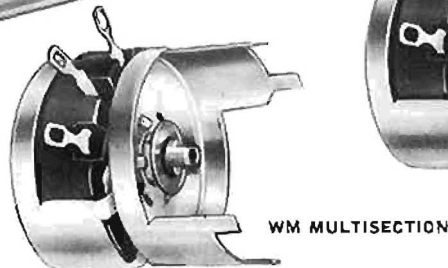

WM MULTISECTION

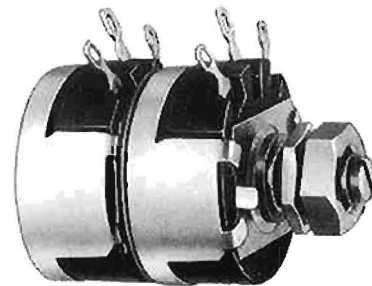

WPRL with Multisection

## TYPE 4/W INDUSTRIAL CONTROLS

IRC Type 4W Controls for industry provide 4 watt (linear) rating in conventional 2 watt size. Available in wide assortment of resistance values. Types WP and WPRL may be combined with Type WM Multisections to provide broad selection of tandem dual controls.

Special platings of metal parts provide outstanding appearance. Resistance tolerance of all units is  $\pm 10\%$ .

### TYPE WP

A wirewound industrial control with  $\frac{3}{8}$ -32 x  $\frac{3}{8}$ " bushing and a full round shaft of  $\frac{1}{4}$ " diameter, approximately 3" long from mounting face. For 2, 3 and 4 watt requirements — 10% tolerance; linear taper; in 36 stock values as listed on the opposite page.

### TYPE WM MULTISECTIONS

These 4 watt Multisections are rear control sections which add to Types WP and WPRL to supply a wide selection of tandem dual controls. Available in 13 factory-assembled stock numbers. WM Multisections do not operate power switches.

### TYPE WPRL

A wirewound industrial control with a short, screwdriver slot shaft of  $\frac{1}{4}$ " diameter and approximately  $\frac{1}{2}$ " long from mounting face, with  $\frac{3}{8}$ " locking type bushing, and locking nut. For 2, 3 and 4 watt requirements — 10% tolerance; linear taper; 36 stock values.

## IRC-CTS TYPE 4/W INDUSTRIAL CONTROLS STOCK LIST

STOCK VALUES OF TYPE WP AND WPRL CONTROLS AND MULTISECTIONS 10% TOLERANCE				
Ohms	Taper	Type WP	Type WPRL	Multisections
2	U (Lin.)	WP2	WPRL2	—
3	U	WP3	WPRL3	—
5	U	WP5	WPRL5	—
6	U	WP6	WPRL6	—
8	U	WP8	WPRL8	—
10	U	WP10	WPRL10	—
15	U	WP15	WPRL15	—
20	U	WP20	WPRL20	—
25	U	WP25	WPRL25	—
30	U	WP30	WPRL30	—
40	U	WP40	WPRL40	—
50	U	WP50	WPRL50	WM50
60	U	WP60	WPRL60	—
75	U	WP75	WPRL75	—
100	U	WP100	WPRL100	WM100
200	U	WP200	WPRL200	WM200
250	U	WP250	WPRL250	WM250
300	U	WP300	WPRL300	—
400	U	WP400	WPRL400	—
500	U	WP500	WPRL500	WM500
750	U	WP750	WPRL750	—
1,000	U	WP1000	WPRL1000	WM1000
1,500	U	WP1500	WPRL1500	WM1500
2,000	U	WP2000	WPRL2000	WM2000
2,500	U	WP2500	WPRL2500	WM2500
3,000	U	WP3000	WPRL3000	WM3000
4,000	U	WP4000	WPRL4000	—
5,000	U	WP5000	WPRL5000	WM5000
7,500	U	WP7500	WPRL7500	—
7,500	L	—	—	WM7500L
10,000	(L.H. Log.)	WP10000	WPRL10000	WM10000
15,000	U	WP15000	WPRL15000	—
20,000	U	WP20000	WPRL20000	—
25,000	U	WP25000	WPRL25000	—
30,000	U	WP30000	WPRL30000	—
40,000	U	WP40000	WPRL40000	—
50,000	U	WP50000	WPRL50000	—

## DIMENSIONS OF TYPE 4/W INDUSTRIAL CONTROLS

Dimension	WP	WPRL
A	$\frac{3}{32}$	$\frac{3}{32}$
B	$1\frac{1}{4}$	$1\frac{1}{4}$
C	$1\frac{1}{2}$	$1\frac{1}{2}$

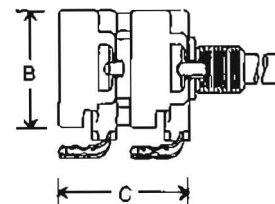
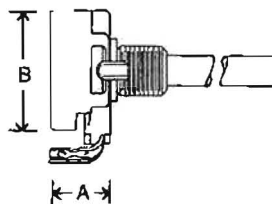





# CARBON & WIREWOUND TRIMMERS



TYPE U-201



TYPE X-201

## U-201 AND X-201 CARBON TRIMMERS

- Miniature Size — Knob 19/32" Diameter
- Arrow Indicator Knob
- Knob Slotted for Front or Rear Screwdriver Adjustment
- Snap-in Self-supporting Bracket Mounted
- Low Cost

### Electrical Specifications

Tolerance:  $\pm 20\%$   
 Power Rating: 1/4 Watt  
 Taper: Linear Only  
 Voltage Rating: 500 VDC Operating Maximum  
 Switches: Not Available  
 Taps: Not Available

### Mechanical Specifications

Mounting: U-201 Mounts with Knob Parallel to Printed Circuit Board  
 X-201 Mounts with Knob Perpendicular to Printed Circuit Board  
 Angle of Rotation:  $260^\circ \pm 5^\circ$   
 Terminals: Printed Circuit Type  
 Adjustment: Blue Nylon Knob 19/32" Diameter, Knurled with Arrow Indicator. Slotted for Front and Rear Adjustment.

### STANDARD RESISTANCE RANGES

STOCK NO.		RESISTANCE VALUE
TYPE U-201	TYPE X-201	
U201R101B	X201R101B	100 $\Omega$
U201R251B	X201R251B	250 $\Omega$
U201R501B	X201R501B	500 $\Omega$
U201R102B	X201R102B	1000 $\Omega$
U201R252B	X201R252B	2500 $\Omega$
U202R502B	X201R502B	5000 $\Omega$
U201R103B	X201R103B	10K $\Omega$
U201R250B	X201R253B	25K $\Omega$
U201R503B	X201R503B	50K $\Omega$
U201R104B	X201R104B	100K $\Omega$
U201R254B	X201R254B	250K $\Omega$
U201R504B	X201R504B	500K $\Omega$
U201R105B	X201R105B	1.0M $\Omega$

Manufactured by CTS Corporation



TYPE P-115



TYPE 117

## TYPE P115 AND 117 WIREWOUND TRIMMERS

- Fully Enclosed Construction
- Long Rotational Life
- Insulated Rotor
- Wide Resistance Range

### Electrical Specifications

Tolerance:  $\pm 10\%$   
 Power Rating: 2 Watts  
 Taper: Linear Only  
 Voltage Rating: 500 VDC Operating Maximum  
 Switches: Not Available  
 Taps: Not Available

### Mechanical Specifications

Mounting: P-115 Twist Tab Mounted  
 117 Rivet Ear Mounted  
 Angle of Rotation:  $270^\circ \pm 5^\circ$   
 Terminals: Printed Circuit Type  
 Adjustment: Cross Slot in Nylon Rotor

### STANDARD RESISTANCE RANGES

STOCK NO.		RESISTANCE
P115R5R0A	117R5R0A	5 $\Omega$
P115R100A	117R100A	10 $\Omega$
P115R250A	117R250A	25 $\Omega$
P115R500A	117R500A	50 $\Omega$
P115R101A	117R101A	100 $\Omega$
P115R251A	117R251A	250 $\Omega$
P115R501A	117R501A	500 $\Omega$
P115R102A	117R102A	1000 $\Omega$
P115R252A	117R252A	2500 $\Omega$
P115R502A	117R502A	5000 $\Omega$
P115R103A	117R103A	10K $\Omega$

Manufactured by CTS Corporation

# CARBON & WIREWOUND CONTROLS

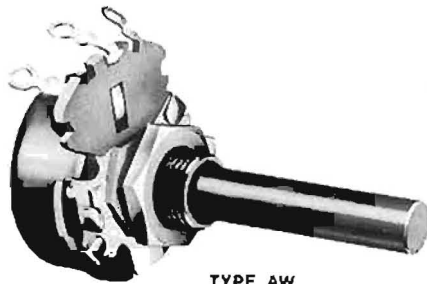

TYPE AW

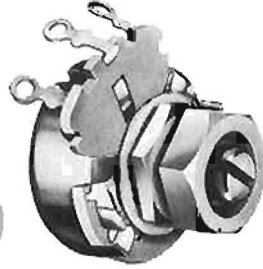

TYPE AWRL

- Compact Size — 15/16" Diameter
- Full 5 Watt Rating
- Economical
- Fully Enclosed Construction

## Electrical Specifications

Tolerance:  $\pm 10\%$

Power Rating: 5 Watts

Taper: Linear Only

Voltage Rating: 500 VDC Operating Maximum

Switches: Not Available

Taps: Not Available

## AW SERIES INDUSTRIAL WIREWOUND CONTROLS

### Mechanical Specifications

Mounting Bushing Dimensions

Diameter: 3/8" — 32 NEF Thread

Length: AW—Non-Lock — 3/8" long

AWRL—Locking — 3/4" long

Angle of Rotation:  $300^\circ \pm 5^\circ$

Shaft Diameter: .250"

Shaft Length: Type AW — 3" F.M.S.

Type AWRL — 1/2" F.M.S.

Shaft Trim: Type AW — Full Round

Type AWRL — Screwdriver Slot

Locating Lugs: Both Sides

### STANDARD RESISTANCE RANGES

AW STOCK NO.	AWRL STOCK NO.	RESISTANCE
AW10	AWRL10	10 $\Omega$
AW15	AWRL15	15 $\Omega$
AW20	AWRL20	20 $\Omega$
AW25	AWRL25	25 $\Omega$
AW50	AWRL50	50 $\Omega$
AW100	AWRL100	100 $\Omega$
AW200	AWRL200	200 $\Omega$
AW250	AWRL250	250 $\Omega$
AW500	AWRL500	500 $\Omega$
AW1000	AWRL1000	1000 $\Omega$
AW2000	AWRL2000	2000 $\Omega$
AW2500	AWRL2500	2500 $\Omega$
AW3000	AWRL3000	3000 $\Omega$
AW5000	AWRL5000	5000 $\Omega$
AW10000	AWRL10000	10K $\Omega$

Manufactured by CTS Corporation

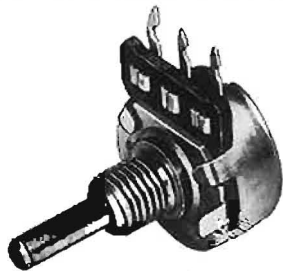

TYPE MC

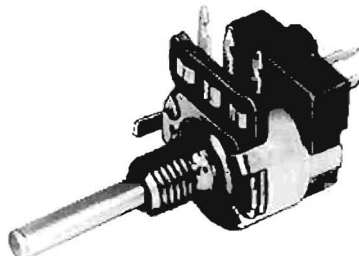

TYPE MCS

- Miniature Size — 3/8" Diameter
- Wide Resistance Range
- Selection of Tapers
- Suitable for Commercial and Replacement Applications

## Electrical Specifications

Tolerance:  $\pm 20\%$

Power Rating: 1/4 Watt

Taper: Linear and Audio

Voltage Rating: 500 VDC Operating Maximum

Switches: SPST Switches Available on Certain Ranges

Taps: Not Available

## SERIES 200 MINIATURE CARBON CONTROLS

### Mechanical Specifications

Mounting Bushing Dimensions

Diameter: 1/4" — 32 NEF-2A

Length: 1/4"

Angle of Rotation

Without Switch —  $300^\circ \pm 5^\circ$

With Switch —  $315^\circ \pm 5^\circ$

Shaft Diameter: .125"

Shaft Length: 1" F.M.S.

Shaft Trim: Screwdriver Slotted

Terminals: Printed Circuit Type

### STANDARD RESISTANCE RANGES

TYPE MC—WITHOUT SWITCH			TYPE MCS—WITH SWITCH		
STOCK NO.	OHMS	TAPER	STOCK NO.	OHMS	TAPER
MC102D	1000 $\Omega$	Linear	MC252AS	2500 $\Omega$	Audio
MC252A	2500 $\Omega$	Audio	MC502AS	5000 $\Omega$	Audio
MC502A	5000 $\Omega$	Audio	MC502DS	5000 $\Omega$	Linear
MC502D	5000 $\Omega$	Linear	MC103AS	10K $\Omega$	Audio
MC103D	10K $\Omega$	Linear	MC504AS	500K $\Omega$	Audio
MC253D	25K $\Omega$	Linear	MC105AS	1.0M $\Omega$	Audio
MC503D	50K $\Omega$	Linear			
MC104D	100K $\Omega$	Linear			
MC254D	250K $\Omega$	Linear			
MC504A	500K $\Omega$	Audio			
MC504D	500K $\Omega$	Linear			
MC105A	1.0M $\Omega$	Audio			
MC105D	1.0M $\Omega$	Linear			

Manufactured by CTS Corporation



# MILITARY CONTROLS

## IRC-CTS MILITARY VARIABLE RESISTORS TO MIL-R-19A AND MIL-R-94B

### GENERAL SPECIFICATIONS

	MIL-R-19A		Char.	MIL-R-94B			
	RA20	RA30		RV2	RV4	RV5	RV6
Resistance Range (ohms)	3-15K	10-25K	X & Y	100-2.5 megs	100-5 megs	250-2.5 megs	1000-1.0 megs
Rotational Life	5% max, 25,000 cycles		X Y	10% max, 15,000 cycles 10% max, 25,000 cycles			
Load Life	3% max, 1,000 hours, rated load, 40°C		X Y	12% max, 1,000 hours, rated load, 70°C 10% max, 1,000 hours, rated load, 70°C			
Moisture Resistance	10% max, Method 106, MIL-STD-202, 35 megs min insulation resistance		X Y	10% average, 14% max, Method 106, MIL-STD-202, 50 megs min insulation resistance 6% average, 10% max, Method 106, MIL-STD-202, 100 megs min insulation resistance			
Low Temp. Storage	4% max		X Y	4% max 2% max			
Low Temp. Operation	4% max		X Y	4% max 3% max			
Thermal Cycling	4% max		X Y	10% max 6% max			
Acceleration	3% max		X & Y	3% max			
Shock	2% max		X & Y	2% max			
High Freq. Vibration	2% max		X & Y	2% max			
Temp. Range	-63°C to +105°C		X & Y	-63°C to 150°C			

Fast, local delivery from Distributors' stock is now available for IRC-CTS military controls. A total of 255 variable resistors is included in this new, local service. The 6 styles illustrated cover the latest MIL-R-94B composition and MIL-R-19A wire wound specifications.

## IRC-CTS WIRE WOUND VARIABLE RESISTORS TO MIL-R-19A

### STYLE RA20 2 WATT WIRE WOUND

Type 252, style RA20, 1 1/16" diameter wirewound variable resistor.



STYLE RA20

- 2 watt rating
- Compact size
- Meets MIL-R-19
- 15 resistance values
- Insulated housing
- Built-in high torque

Choice of 2 shaft styles, plain or locking bushings.

#### Resistance

3 ± 10%
10 ± 10%
25 ± 10%
50 ± 10%
75 ± 10%
100 ± 10%
200 ± 10%
250 ± 10%
500 ± 10%
1,000 ± 10%
2,500 ± 10%
5,000 ± 10%
7,500 ± 10%
10,000 ± 10%
15,000 ± 10%

### IRC-CTS TYPE 252

7/8" Slotted Shaft  
3/8" Long Bushing  
Linear Resistance Taper

RA20NASD3R0A
RA20NASD100A
RA20NASD250A
RA20NASD500A
RA20NASD750A
RA20NASD101A
RA20NASD201A
RA20NASD251A
RA20NASD501A
RA20NASD102A
RA20NASD252A
RA20NASD502A
RA20NASD752A
RA20NASD103A
RA20NASD153A

### CTS TYPE 252LT

5/8" Slotted Shaft 7/8" Slotted Shaft  
1/2" Long 1/2" Long  
Locking Bushing Locking Bushing  
Linear Resistance Linear Resistance  
Taper Taper

RA20LASB3R0A	RA20LASB150A
RA20LASB100A	—
RA20LASB250A	RA20LASD250A
RA20LASB500A	RA20LASD500A
RA20LASB750A	—
RA20LASB101A	RA20LASD101A
RA20LASB201A	—
RA20LASB251A	RA20LASD251A
RA20LASB501A	RA20LASD501A
RA20LASB102A	RA20LASD102A
RA20LASB252A	RA20LASD252A
RA20LASB502A	RA20LASD502A
RA20LASB752A	RA20LASD752A
RA20LASB103A	RA20LASD103A
RA20LASB153A	RA20LASD153A

### STYLE RA30 4 WATT WIRE WOUND

Type 25, style RA30, 1 1/16" diameter wirewound variable resistor.

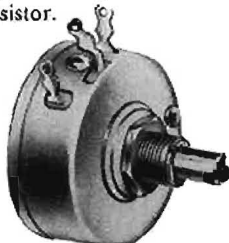

STYLE RA30

- 4 watt rating
- Reliable CTS wirewound element
- Meets all MIL-R-19 requirements
- 15 resistance values
- Built-in high torque

Choice of 2 shaft styles, plain or locking bushings.

#### Resistance

10 ± 10%
25 ± 10%
50 ± 10%
100 ± 10%
250 ± 10%
500 ± 10%
750 ± 10%
1,000 ± 10%
2,500 ± 10%
5,000 ± 10%
7,500 ± 10%
10,000 ± 10%
15,000 ± 10%
25,000 ± 10%

### IRC-CTS TYPE 25

7/8" Slotted Shaft  
3/8" Long Bushing  
Linear Resistance Taper

RA30NASD100A
RA30NASD250A
RA30NASD500A
RA30NASD750A
RA30NASD101A
RA30NASD201A
RA30NASD251A
RA30NASD501A
RA30NASD751A
RA30NASD102A
RA30NASD252A
RA30NASD502A
RA30NASD752A
RA30NASD103A
RA30NASD153A
RA30NASD253A

### CTS TYPE 25LT

5/8" Slotted Shaft  
1/2" Long Locking Bushing  
Linear Resistance Taper

RA30LASB100A
RA30LASB250A
RA30LASB500A
RA30LASB101A
RA30LASB201A
RA30LASB251A
RA30LASB501A
RA30LASB751A
RA30LASB102A
RA30LASB252A
RA30LASB502A
RA30LASB752A
RA30LASB103A
RA30LASB153A
RA30LASB253A



## IRC-CTS COMPOSITION VARIABLE RESISTORS TO MIL-R-94B

### STYLE RV2 1 WATT COMPOSITION

Type 90, style RV2, 1 5/8" diameter composition variable resistor.



- 1 watt rating
- Operational up to 150°C
- 14 resistance values
- Meets characteristics X and Y
- Designed for high temperature and humidity military applications

STYLE RV2

Choice of 2 shaft styles, plain or locking bushings.

Resistance	IRC-CTS TYPE 90 3/8" Slotted Shaft 3/8" Long Bushing Linear Resistance Taper		CTS TYPE 90LT 3/8" Slotted Shaft 1/2" Long Locking Bushing Linear Resistance Taper	
	RV2NAXSD	RV2NAYSD	RV2LAXSA	RV2LAYSA
100 ± 10%	RV2NAXSD101A	RV2NAYSD101A	RV2LAXSA101A	RV2LAYSA101A
250 ± 10%	RV2NAXSD251A	RV2NAYSD251A	RV2LAXSA251A	RV2LAYSA251A
500 ± 10%	RV2NAXSD501A	RV2NAYSD501A	RV2LAXSA501A	RV2LAYSA501A
1,000 ± 10%	RV2NAXSD102A	RV2NAYSD102A	RV2LAXSA102A	RV2LAYSA102A
2,500 ± 10%	RV2NAXSD252A	RV2NAYSD252A	RV2LAXSA252A	RV2LAYSA252A
5,000 ± 10%	RV2NAXSD502A	RV2NAYSD502A	RV2LAXSA502A	RV2LAYSA502A
10,000 ± 10%	RV2NAXSD103A	RV2NAYSD103A	RV2LAXSA103A	RV2LAYSA103A
25,000 ± 10%	RV2NAXSD253A	RV2NAYSD253A	RV2LAXSA253A	RV2LAYSA253A
50,000 ± 10%	RV2NAXSD503A	RV2NAYSD503A	RV2LAXSA503A	RV2LAYSA503A
100,000 ± 10%	RV2NAXSD104A	RV2NAYSD104A	RV2LAXSA104A	RV2LAYSA104A
250,000 ± 10%	RV2NAXSD254A	RV2NAYSD254A	RV2LAXSA254A	RV2LAYSA254A
500,000 ± 10%	RV2NAXSD504A	RV2NAYSD504A	RV2LAXSA504A	RV2LAYSA504A
1.0 Meg. ± 20%	RV2NAXSD105B	RV2NAYSD105B	RV2LAXSA105B	RV2LAYSA105B
2.5 Meg. ± 20%	RV2NAXSD255B	RV2NAYSD255B	RV2LAXSA255B	RV2LAYSA255B

### STYLE RV4 3 WATT COMPOSITION

Type 96/320/321, style RV4, 1 1/8" diameter composition variable resistor



STYLE RV4

- 3 watt rating
- Completely enclosed construction
- Excellent heat sink qualities
- 15 resistance values
- Long life, no noise
- Reliable carbon-ceramic element

Choice of 2 shaft styles, plain or locking bushings.

Resistance	IRC-CTS TYPE 96/320/321 3/8" Slotted Shaft 3/8" Long Bushing Linear Resistance Taper		CTS TYPE 96LT/320LT/321LT 3/8" Slotted Shaft 1/2" Long Locking Bushing Linear Resistance Taper	
	RV4NAXSD	RV4NAYSD	RV4LAXSA	RV4LAYSA
100 ± 10%	RV4NAXSD101A	RV4NAYSD101A	RV4LAXSA101A	RV4LAYSD101A
250 ± 10%	RV4NAXSD251A	RV4NAYSD251A	RV4LAXSA251A	RV4LAYSD251A
500 ± 10%	RV4NAXSD501A	RV4NAYSD501A	RV4LAXSA501A	RV4LAYSD501A
1,000 ± 10%	RV4NAXSD102A	RV4NAYSD102A	RV4LAXSA102A	RV4LAYSD102A
2,500 ± 10%	RV4NAXSD252A	RV4NAYSD252A	RV4LAXSA252A	RV4LAYSD252A
5,000 ± 10%	RV4NAXSD502A	RV4NAYSD502A	RV4LAXSA502A	RV4LAYSD502A
10,000 ± 10%	RV4NAXSD103A	RV4NAYSD103A	RV4LAXSA103A	RV4LAYSD103A
25,000 ± 10%	RV4NAXSD253A	RV4NAYSD253A	RV4LAXSA253A	RV4LAYSD253A
50,000 ± 10%	RV4NAXSD503A	RV4NAYSD503A	RV4LAXSA503A	RV4LAYSD503A
100,000 ± 10%	RV4NAXSD104A	RV4NAYSD104A	RV4LAXSA104A	RV4LAYSD104A
250,000 ± 10%	RV4NAXSD254A	RV4NAYSD254A	RV4LAXSA254A	RV4LAYSD254A
500,000 ± 10%	RV4NAXSD504A	RV4NAYSD504A	RV4LAXSA504A	RV4LAYSD504A
1.0 Meg. ± 10%	RV4NAXSD105A	RV4NAYSD105A	RV4LAXSA105A	RV4LAYSD105A
1.0 Meg. ± 20%	RV4NAXSD105B	RV4NAYSD105B	RV4LAXSA105B	—
2.5 Meg. ± 20%	RV4NAXSD255B	RV4NAYSD255B	RV4LAXSA255B	—
5.0 Meg. ± 20%	RV4NAXSD505B	RV4NAYSD505B	RV4LAXSA505B	—

### STYLE RV5 1/2 WATT MINIATURE COMPOSITION

Type 65, style RV5, 3/4" diameter composition resistor.



STYLE RV5

- 1/2 watt rating
- Small size
- 13 resistance values
- Operational up to 150°C
- Designed for high temperature and humidity applications

Choice of 2 shaft styles, plain or locking bushings.

Resistance	IRC-CTS TYPE 65 3/8" Slotted Shaft 1/4" Long Bushing Linear Resistance Taper		CTS TYPE 65LT 3/8" Slotted Shaft 3/8" Long Locking Bushing Linear Resistance Taper	
	RV5NAXSD	RV5NAYSD	RV5LAXSB	RV5LAYSB
250 ± 10%	RV5NAXSD251A	RV5NAYSD251A	RV5LAXSB251A	RV5LAYSB251A
500 ± 10%	RV5NAXSD501A	RV5NAYSD501A	RV5LAXSB501A	RV5LAYSB501A
1,000 ± 10%	RV5NAXSD102A	RV5NAYSD102A	RV5LAXSB102A	RV5LAYSB102A
2,500 ± 10%	RV5NAXSD252A	RV5NAYSD252A	RV5LAXSB252A	RV5LAYSB252A
5,000 ± 10%	RV5NAXSD502A	RV5NAYSD502A	RV5LAXSB502A	RV5LAYSB502A
10,000 ± 10%	RV5NAXSD103A	RV5NAYSD103A	RV5LAXSB103A	RV5LAYSB103A
25,000 ± 10%	RV5NAXSD253A	RV5NAYSD253A	RV5LAXSB253A	RV5LAYSB253A
50,000 ± 10%	RV5NAXSD503A	RV5NAYSD503A	RV5LAXSB503A	RV5LAYSB503A
100,000 ± 10%	RV5NAXSD104A	RV5NAYSD104A	RV5LAXSB104A	RV5LAYSB104A
250,000 ± 10%	RV5NAXSD254A	RV5NAYSD254A	RV5LAXSB254A	RV5LAYSB254A
500,000 ± 10%	RV5NAXSD504A	RV5NAYSD504A	RV5LAXSB504A	RV5LAYSB504A
1.0 Meg. ± 20%	RV5NAXSD105B	RV5NAYSD105B	RV5LAXSB105B	RV5LAYSB105B
2.5 Meg. ± 20%	RV5NAXSD255B	RV5NAYSD255B	RV5LAXSB255B	RV5LAYSB255B

### STYLE RV6 1/2 WATT MINIATURE COMPOSITION

Type 300, style RV6, 1/2" diameter composition resistor.



STYLE RV6

- 1/2 watt rating
- Miniature size
- Excellent stability
- 14 resistance values
- Reliable carbon-ceramic element
- High resolution

Choice of 2 shaft styles, plain or locking bushings.

Resistance	IRC-CTS TYPE 300 3/8" Slotted Shaft 1/4" Long Bushing Linear Resistance Taper		CTS TYPE 300LT 3/8" Slotted Shaft 1/2" Long Locking Bushing Linear Resistance Taper	
	RV6NAXSD	RV6NAYSD	RV6LAXSA	RV6LAYSA
100 ± 10%	RV6NAXSD101A	RV6NAYSD101A	RV6LAXSA101A	RV6LAYSA101A
250 ± 10%	RV6NAXSD251A	RV6NAYSD251A	RV6LAXSA251A	RV6LAYSA251A
500 ± 10%	RV6NAXSD501A	RV6NAYSD501A	RV6LAXSA501A	RV6LAYSA501A
1,000 ± 10%	RV6NAXSD102A	RV6NAYSD102A	RV6LAXSA102A	RV6LAYSA102A
2,500 ± 10%	RV6NAXSD252A	RV6NAYSD252A	RV6LAXSA252A	RV6LAYSA252A
5,000 ± 10%	RV6NAXSD502A	RV6NAYSD502A	RV6LAXSA502A	RV6LAYSA502A
10,000 ± 10%	RV6NAXSD103A	RV6NAYSD103A	RV6LAXSA103A	RV6LAYSA103A
25,000 ± 10%	RV6NAXSD253A	RV6NAYSD253A	RV6LAXSA253A	RV6LAYSA253A
50,000 ± 10%	RV6NAXSD503A	RV6NAYSD503A	RV6LAXSA503A	RV6LAYSA503A
100,000 ± 10%	RV6NAXSD104A	RV6NAYSD104A	RV6LAXSA104A	RV6LAYSA104A
250,000 ± 10%	RV6NAXSD254A	RV6NAYSD254A	RV6LAXSA254A	RV6LAYSA254A
500,000 ± 10%	RV6NAXSD504A	RV6NAYSD504A	RV6LAXSA504A	RV6LAYSA504A
1.0 Meg. ± 20%	RV6NAXSD105B	RV6NAYSD105B	RV6LAXSA105B	RV6LAYSA105B
2.0 Meg. ± 20%	RV6NAXSD205B	RV6NAYSD205B	RV6LAXSA205B	RV6LAYSA205B
2.5 Meg. ± 20%	RV6NAXSD255B	RV6NAYSD255B	RV6LAXSA255B	RV6LAYSA255B



# INDUSTRIAL VARIABLE RESISTORS

## IRC-CTS TYPE 321/RV4 THREE-WATT INDUSTRIAL CONTROL (MILITARY GRADE)

### FEATURES

- COMPLETELY ENCLOSED CONSTRUCTION
- CARBON-CERAMIC ELEMENT
- EXCELLENT HEAT SINK QUALITIES
- MEETS MIL-R-94B, STYLE RV4
- HIGH INSULATION RESISTANCE OF CERAMIC
- LONG LIFE, LOW NOISE
- LARGE SAFETY FACTOR

### ELECTRICAL AND MECHANICAL SPECIFICATIONS

- **RESISTANCE RANGE**  
250 ohms through 2.5 megohms (linear taper).
- **TOLERANCE**  
+ 10% standard, -1.20% standard for values 1 megohm and above.
- **TAPERS . . . Linear**
- **WATTAGE AND TEMPERATURE RATING**  
3 watts at 70°C or 2 watts at 95°C derated to no load at 150°C.  
500 volts DC maximum safe operating voltage across resistance element.
- **MOUNTING BUSHING DIMENSIONS**  
Diameter:  $\frac{3}{8}$ " - 32 N.E.F. thread  
Length: Non-Lock —  $\frac{3}{8}$ " standard  
Locking —  $\frac{1}{2}$ " standard
- **ANGLE OF ROTATION . . .  $315^\circ \pm 5^\circ$**
- **SHAFT DIAMETER . . .  $.250" \pm .001"$**
- **SHAFT LENGTH**  
As shown under Ordering Information below.
- **SHAFT TRIM**  
Screwdriver slot (Type LT) standard.
- **LOCATING LUGS**  
Standard position is left side (terminals down) as illustrated.
- **TAPS . . . None.**

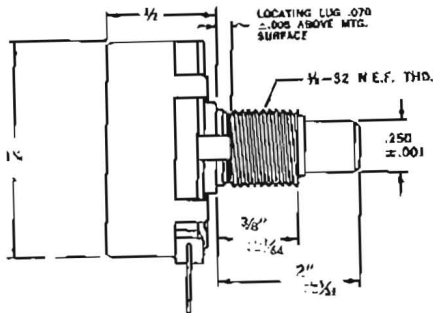

SIDE VIEW OF TYPE 321S CONTROL

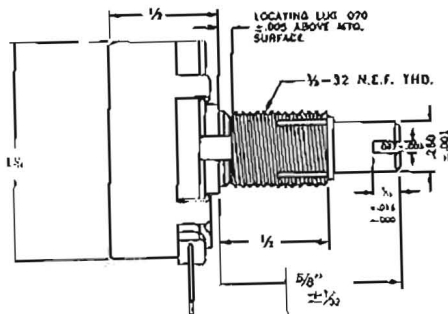

SIDE VIEW OF TYPE 321LT CONTROL WITH LOCKING BUSHING

### RANGES

TYPE 321S/RV4 2" plain shaft $\frac{3}{8}$ " long bushing	TOTAL RESISTANCE	TYPE 321LT/RV4NAYS $\frac{5}{8}$ " slotted shaft $\frac{1}{2}$ " long locking bushing
<b>PART NUMBER</b>	(Ohms $\pm 10\%$ )	<b>PART NUMBER</b>
321S251A/RV4NAY251A	250	321LT251A/RV4NAYS251A
321S501A/RV4NAY501A	500	321LT501A/RV4NAYS501A
321S102A/RV4NAY102A	1,000	321LT102A/RV4NAYS102A
321S252A/RV4NAY252A	2,500	321LT252A/RV4NAYS252A
321S502A/RV4NAY502A	5,000	321LT502A/RV4NAYS502A
321S103A/RV4NAY103A	10,000	321LT103A/RV4NAYS103A
321S253A/RV4NAY253A	25,000	321LT253A/RV4NAYS253A
321S503A/RV4NAY503A	50,000	321LT503A/RV4NAYS503A
321S104A/RV4NAY104A	100,000	321LT104A/RV4NAYS104A
321S254A/RV4NAY254A	250,000	321LT254A/RV4NAYS254A
321S504A/RV4NAY504A	500,000	321LT504A/RV4NAYS504A
	(Ohms $\pm 20\%$ )	
321S105B/RV4NAY105B	1 Megohm	321LT105B/RV4NAYS105B
321S255B/RV4NAY255B	2.5 Megohms	321LT255B/RV4NAYS255B

# AUTO RADIO CONTROLS

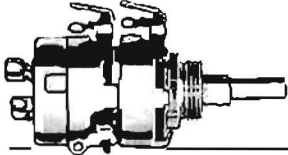

**EXACT DUPLICATE CONTROLS** For 298 different makes and models. IRC-CTS's line of exact duplicate controls includes 137 individual types. Faster servicing results from these top-quality controls because of IRC-CTS's strict adherence to manufacturer's specifications.

IRC-CTS Part No.	Year	Radio Mfr.	Radio Model No.	Original Part No.
------------------	------	------------	-----------------	-------------------

**AMERICAN MOTORS**

5563	1959	Motorola	94MA	188561728
------	------	----------	------	-----------

**BUICK**

5346	1946-53	Motorola	BK2A, BK3A8	18D512084
8350	1954-56	Motorola		18X533457
5359	1957	Motorola		188540768
5411	1950-53	Delco	980868, 980899, 980979, 980980, 981111, 981320, 981321, 981322, 981323	7263119
5412	1954	Delco	981550, 981551	7264309
5413	1955	Delco	981651, 981652	7265742
5414	1956	Delco	981707, 981708	7266996
5415	1957	Delco	981813, 981814	7268944
5553	1958	Delco	981902	7271329
5558	1959	Delco	986822	7271446
6001	1960	Delco		7276365
6104	1961	Delco	980134/5	7277155

**CADILLAC**

5423	1950-52	Delco	7258865, 7260405, 7259825, 7260905, 7260705	7259240
5424	1953	Delco	7262645, 7262695, 7263525, 7263545, 7263835	7263321
5425	1954-55	Delco	7264165, 7264185, 7264195, 7265825, 7265845, 7265855	7264638
5426	1956	Delco	7265855, 7266505, 7266535, 7266565	7266982
5427	1957	Delco	7268005, 7268035, 7268085	7269443

**CHEVROLET**

5342	1949-50	Delco	986240, 986388	7258084
5343	1950	Delco	986389	1218641
5344	1951-52	Delco	986516	1219708
5345	1951-52	Delco	986515	7261385
5346	1951-52	Motorola	CT2A, CT2M	188512084
5347	1953-54	Delco	986669	7262941
5348	1953-54	Delco	986771	7264211
5349	1953-54	Delco	986668	7264210
5350	1953-56	Motorola		18X533457
5351	1955	Delco	987087	7265285
5352	1955-56	Delco	987088, 987366	7265220
5353	1955-57	Delco	987086, 987364, 3725156	7265302
5354	1955-58	Delco	987187	7266193
5355	1956	Delco	987368	7266842
5356	1957	Delco	987577	7269211
5357	1957	Delco	987575, 987693	7269199
5358	1957	Delco	987573	7269186
5359	1957	Motorola		188540768
5360	1957	Motorola	CTA7X, CTM7X	18X541128
5362	1957	Delco		7270202
5550	1958	Delco	987724	7270450
5551	1958	Delco	987727	7270479
5555	1959	Delco	987888	7273302
5556	1959	Delco	987891	7273367
6002	1960	Delco	988276	7275710
6101	1961	Delco	985036	7278528
6105	1961	Delco	988414	7276939
6201	1962	Delco	985264	7279855
6301	1963	Delco	985432	7282598
6302	1963	Delco	985431	7282088
6401	1964	Delco	985877	7287414
6402	1964	Delco	985875	7287355

**CHEVROLET TRUCKS**

5348	1948-53	Motorola	GMT2A, GMT2M	188512084
5361	1950-52	Delco	986067, 986443	7256188

**CHRYSLER**

5378	1955	Philco	C-5509, Mopar 835	33-5557-15
			C-5609	
5435	1953	Philco	C-5109, Mopar 812	33-5557-10
			C-5209, Mopar 817	
			C-5110, Mopar 813	
			C-5211	
			C-5111, Mopar 815	
			C-5212	

IRC-CTS Part No.	Year	Radio Mfr.	Radio Model No.	Original Part No.
------------------	------	------------	-----------------	-------------------

**CHRYSLER (Cont.)**

5436	1953-54	Philco	C-5112, Mopar 816 C-5409, Mopar 824 C-5410, Mopar 830 C-5411	33-5557-13
5437	1955	Philco	C-5595, Mopar 902	33-5557-16
5438	1957	Philco	C-5596, Mopar 903	
5439	1957	Philco	C-5696, Mopar 912	33-5557-16
5558	1959	Motorola	C-5705, Mopar 847	33-5580-16
			C-5707	33-5580-13
			Mopar 861	188561364

**CONTINENTAL**

5398	1956	Bendix	6BC	L219660-2
------	------	--------	-----	-----------

**CORDVAIR**

6004	1960	Delco	988062	7274920
6102	1961	Delco	988460	7278058

**DE SOTO**

5449	1954	Motorola	Mopar 829	18A530623
5450	1955-56	Motorola	Mopar 911	18B532633
5451	1957	Motorola	Mopar 846	18B539819
			919, 919HR	
5451	1958	Motorola	Mopar 923	18B539819

**DODGE**

5459	1953	Motorola	Mopar 609	18B521099
5460	1954-55	Motorola	Mopar 833	18X533013
5461	1955	Motorola	Mopar 814, 621	18B532519
5462	1955-56	Motorola	Mopar 900, 901, 910	18X532955
5463	1957	Motorola	Mopar 845, 918	18X539820
5464	1958	Motorola	Mopar 502	18B561317
5564	1959	Motorola	Mopar 856	18B561732
6007	1960	Motorola		18B563115

**EDSEL**

5562	1959	Bendix	94BE	2090035-3
------	------	--------	------	-----------

**FORD**

5308	1948-50	Bendix	M1, M1A, M1A1	L222808
5309	1950	Motorola	OMF	18B591266
5310	1951	Bendix	M2	L219586-2
5311	1951	Motorola	1MF	18B501153
5312	1952-53	Bendix	M4, M4A	L219586-3
5313	1952-53	Motorola	2MF, 3MF	18X511635
5314	1954	Bendix	M4B, M4BA, M4BP	L219586-7
5315	1954	Motorola	4MF	18B530018
5316	1955	Bendix	5BF, 5BF8	L219656-1
5317	1955	Motorola	5MF, 5MF8	18B531299
5318	1956	Bendix	R6BF	L219681-1
5319	1956	Motorola	66MF, 66MFP, 69MF	18B534483
5320	1957	Bendix	R75BF	2090035-1
5321	1957	Motorola	75MF	18X539059
5322	1957	Motorola	78MF	18B539379
5323	1957-58	Bendix	R74BF, R84BF	2090035-2
5324	1957-58	Motorola	74MF, 84MF	18B541819
5325	1957-58	Motorola	76MF(SA), 86MF	18B542373
5560	1959	Motorola	94MF, 94MFM	
5561	1959	Motorola	95MF	18B561599
5562	1959	Bendix	94BF	
6005	1960	Bendix	04BF	2090405-1
6008	1960	Motorola	14MO, 14MF, 14MFM	18C562768
6106	1961	Bendix	14BF	2090405-8
6202	1962	Motorola	21MF	18C1134A01
6303	1963-64	Motorola	31MF, 4TMF	18C41449A03
6304	1963-64	Bendix	3TBO	2092097-4
6305	1963	Bendix	3TBD	2091619-3
6403	1964	Bendix	4TBD	2092097-6

**BMC TRUCKS**

5346	1948-53	Motorola	GMT2A, GMT2M	188512084
5348	1954-58	Delco	2233396, 2233398, 2233478, 2233480	7264211
5354	1955-56	Delco	2233478, 2233480, 2233029, 2233297	7266193
5361	1947-52	Delco		7256188

**KAISER**

5346	1951-53	Motorola	KR2A, KR2M	188512084
------	---------	----------	------------	-----------

IRC-CTS Part No.	Year	Radio Mfr.	Radio Model No.	Original Part No.
------------------	------	------------	-----------------	-------------------

**LINCOLN**

5398	1955-56	Bendix		L219660-2
------	---------	--------	--	-----------

**MERCURY**

5398	1955-56	Bendix	R6BM	L219660-2
5399	1957	Philco	M-5841, M-5741	33-5570-2
5400	1958	Bendix	R84BM, R85BM-5	N219689-4
6106	1961	Bendix	14BF	2090405-8

**OLDSMOBILE**

5346	1951-52	Motorola	OE2A, OE2M	188512084
5350	1954-56	Motorola		18X533457
5473	1949	Delco	982420	1219582
5474	1951	Delco	982700	7260294
5475	1953	Delco	983004	7263540
5476	1954-55	Delco	983090, 983204	7264242
5477	1954-56	Delco	983091, 983205, 983336	7264128
5478	1956	Delco	98334	7266887
5479	1957	Delco	989002	7268847
5480	1957	Delco	989001	7269055
5552	1958	Delco	989127, 989129	7270679

**PACKARD**

5346	1951-53	Motorola	PO2A, PO2M	188512084
5494	1956	Delco	480487, 6480487	7267632

**PLYMOUTH**

5373	1952	Motorola	Mopar 606	18A501616
5374	1953	Motorola	Mopar 608 P-5206,	18B521635 33-5557-11
5375	1953	Philco	Mopar 819	
5376	1954-55	Motorola	Mopar 836	18A533014
5377	1955	Motorola	Mopar 613	18X532909
5378	1955	Philco	P-5506, Mopar 832	33-5557-15
5379	1956	Motorola	Mopar 841	18X536152
5380	1956	Motorola	Mopar 916	18B536704
5381	1956	Philco	P-5606, Mopar 840	33-5580-4
5382	1957	Motorola	Mopar 849	18B540376
5383	1957	Philco	P-5701, Mopar 848 P-5702, Mopar 848	33-5580-12
5384	1958	Motorola	Mopar 854	18B560415
5385	1958	Philco	P-5801	33-5580-21
5386	1955	Philco		33-5557-14
5559	1959	Motorola	Mopar 860	
6006	1960	Motorola	101, 104, 110	18B563140

**PONTIAC**

5350	1955-56	Motorola		18X533457
5359	1957	Motorola		18B540768
5501	1949-50	Delco	984296, 984570	7257708
5502	1951-52	Delco	984592, 984688	7260043
5503	1953-54	Delco	984817	7262482
5504</				



# SPECIAL PURPOSE CONTROLS

## 2 WATT, 3/4" DIAMETER WIREWOUND CONTROLS

IRC buzz-bias controls are 2 watt preset type wirewound resistors. They are designed for hum-balancing, sensitivity, bias-adjust, AGC, holding, locking, and other radio and TV applications. All units are  $\pm 20\%$  tolerance, linear taper, and have contact arm grounded to housing. Manufactured by CTS Corporation.

### TYPE 110—TAB-MOUNT UNIT



TYPES 110 & 110D

IRC STOCK NO.	RESISTANCE
110-1.5	1.5 $\Omega$
110-5	5 $\Omega$
110-15	15 $\Omega$
110-60	60 $\Omega$
110-100	100 $\Omega$
110-300	300 $\Omega$
110-600	600 $\Omega$
110-1000	1000 $\Omega$
110-3000	3000 $\Omega$
110-3000-350	3000 Stops at 350 $\Omega$

### TYPE 112—FLANGE MOUNT UNITS

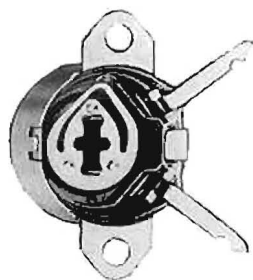

TYPE 112

IRC STOCK NO.	RESISTANCE
112-50	50 $\Omega$
112-100	100 $\Omega$
112-150	150 $\Omega$
112-200	200 $\Omega$
112-300	300 $\Omega$
112-500	500 $\Omega$
112-500-100	500 $\Omega$ Stops at 100 $\Omega$
112-600	600 $\Omega$
112-650	650 $\Omega$
112-800	800 $\Omega$
112-800-50	850 $\Omega$ Stops at 50 $\Omega$
112-1000	1000 $\Omega$
112-1000-100	1000 $\Omega$ Stops at 100 $\Omega$
112-1500	1500 $\Omega$
112-2000	2000 $\Omega$
112-2000-100	2000 $\Omega$ Stops at 100 $\Omega$
112-2500-700	2500 $\Omega$ Stops at 700 $\Omega$
112-3000	3000 $\Omega$
112-4000	4000 $\Omega$
112-4000-350	4000 $\Omega$ Stops at 350 $\Omega$
112-4000-1000	4000 $\Omega$ Stops at 1000 $\Omega$
112-5000	5000 $\Omega$
112-10K	10K $\Omega$

### TYPE 110D—TAB-MOUNT SPECIAL TEMPERATURE COMPENSATED UNITS

IRC STOCK NO.	RESISTANCE
110D175-60	175 $\Omega$ Stops at 60 $\Omega$ Replaces Delco #7275554
110D260-90	260 $\Omega$ Stops at 90 $\Omega$ Replaces Delco #7275474

### TYPE 110C—TAB-MOUNT TV COLOR CONVERGENCE CONTROLS WITH INTEGRAL NYLON KNOBS

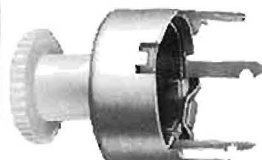

TYPE 110C

IRC STOCK NO.	RESISTANCE
110C-10	10 $\Omega$
110C-30	30 $\Omega$
110C-60	60 $\Omega$
110C-120	120 $\Omega$
110C-150	150 $\Omega$

## L & T ATTENUATOR PADS



IRC-CTS L and T pads provide constant impedance for use in sound systems and for speaker controls. Both types handle up to 15 watts audio power (5 watts DC). L pads provide a constant input impedance and T pads provide constant input and output impedances.

#### ELECTRICAL SPECIFICATIONS:

Continuous D.C. Rating:	5 watts
Peak Audio Rating:	15 watts
Dielectric Strength:	1000 V.A.C. RMS to Ground
Attenuation Range:	4, 8 and 16 $\Omega$ IMPEDANCES: 0 to 30 db 500 $\Omega$ IMPEDANCE: 0 to 40 db
Insertion Loss:	Negligible (less than .5 db)
Input Impedance:	Constant within +30% -20%

#### MECHANICAL SPECIFICATIONS:

Size:	3/8" diameter
Shaft Dimensions:	
Diameter:	.250"
Length:	2" from mounting surface
Bushing:	3/8"-.32 x 3/8" long bushing
Angle of Rotation:	300° $\pm$ 5°

IRC Stock No.	IMPEDANCE
<b>L PADS</b>	
LP4A	4 $\Omega$
LP8A	8 $\Omega$
LP15A	15 $\Omega$
LP500A	500 $\Omega$
<b>T PADS</b>	
TP4A	4 $\Omega$
TP8A	8 $\Omega$
TP15A	15 $\Omega$
TP500A	500 $\Omega$

# SPECIAL PURPOSE CONTROLS

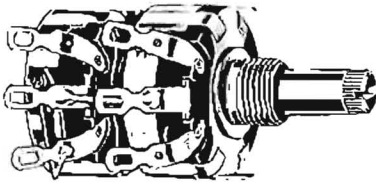

**TV ATTENUATORS** for on-the-spot adjustment of signal input to TV set. In most cases it corrects or reduces adjacent channel interference, background picture on weaker stations, poor definition, picture and sound break-over. Type QJ-3 is widely used in service work to duplicate fringe area signals when near strong local station.



**LOUDNESS CONTROLS** that are continuously compensated to boost lows and highs as volume is decreased. Maintains depth and brilliance even at whisper level. The LC-2 can easily be wired into most audio circuits. Typical installation instructions included. Uses types 76-1, 76-2 or 76-4 switches.

## TV HEIGHT CONTROLS

### AVOID CALL-BACK INCONVENIENCES



#### USES

This control is supplied for reliable replacement of TV Height Controls and other controls in B+C CIRCUITS — such as AGC,

NOISE GATE,

FOCUS,

FRINGE LOCK and

SYNC controls — which have become unsatisfactory because of element etching due to voltages present in the particular circuitry.

#### FEATURES

- Premium quality control (originally designed for rugged service in military gear)
- 1 watt rating, 750 V. max. between outer terminals
- Small size — 15/16" diameter — same as most original controls
- Nylon shaft — slotted and knurled — easily shortened where required
- Tab mounting
- Rear adjustment

#### TYPE HLC TV HEIGHT CONTROLS

IRC Stock No.	Resistance Value
HLC-1	2.0 Meg. $\pm$ 30%
HLC-2	2.5 Meg. $\pm$ 30%
HLC-3	3.0 Meg. $\pm$ 30%
HLC-4	4.0 Meg. $\pm$ 30%
HLC-5	5.0 Meg. $\pm$ 30%
HLC-6	7.5 Meg. $\pm$ 30%





# ROTARY SELECTOR SWITCHES

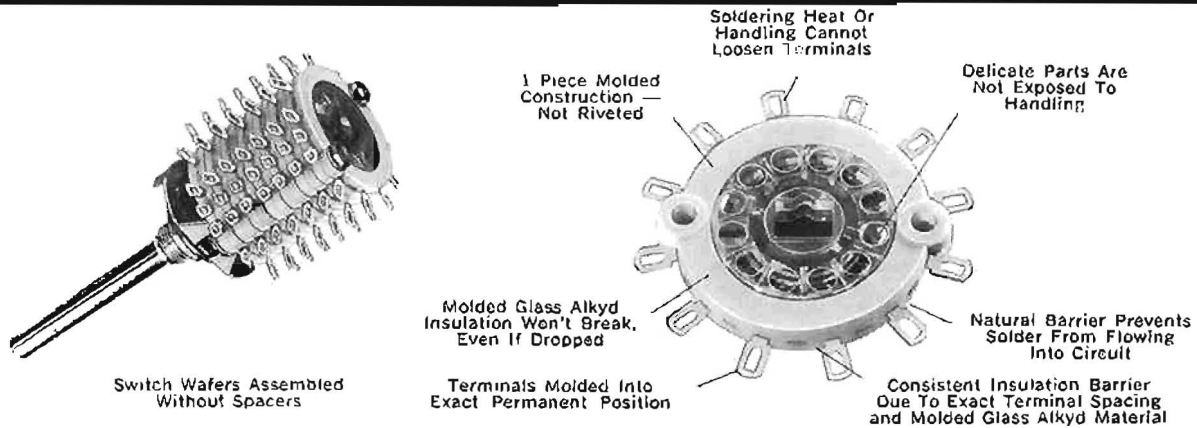

## SELECTOR SWITCH UNIQUE 1-PIECE MOLDED WAFER PROVIDES HIGH RELIABILITY

The new IRC-CTS design goes right to the heart of selector switch reliability . . . the wafer. Automated manufacture provides unprecedented uniformity. One-piece *molded* construction of the wafer virtually eliminates drift. In each production run, all switches are identical, terminal placement is exact and permanent. Machine exactness replaces human error and variation, eliminating wide tolerances and assuring high reliability.

- Compact  $1\frac{1}{8}$ " size design allows more circuitry per unit of depth behind panel.
- Rivet-free construction permits closer stacking.
- Superior insulation due to repetitive exactness in terminal spacing, and molded glass alkyd material.
- 1000% more silver than used by most commercial switches—evenly applied at point of contact.
- Rotor contacts are double-wiping and self-cleaning.
- Stator contacts are integral with terminals.
- Molded stator will not break or crush during ordinary handling, or if it is dropped.

### GENERAL SPECIFICATIONS

INSULATION:	COMMERCIAL TYPE 212 SERIES Stator—Glass Alkyd Resin Rotor—Polycarbonate (Lexan)	INDUSTRIAL-MILITARY TYPE M-212 SERIES Stator—Type MAI-30 per MIL-M-21699 Rotor—IL grade glass-filled nylon
STATOR CONTACTS AND TERMINAL LUG MATERIAL	Laminated silver movable contacts. Terminals and stator are brass, silver plated.	Military grade laminated silver. Silver plated movable contacts. Terminals and stator are brass, silver plated.
OPERATING TEMPERATURE:	85° C.	125° C.
DETENTS:	Index plate 30° between positions with one fixed and one adjustable stop.	Index plate 30° between positions with one fixed and one adjustable stop.
FINISH:	50-hour salt spray.	50-hour salt spray.
MOUNTING DETAILS:	Bushing— $\frac{3}{8}$ "-32 thread, $\frac{3}{8}$ " long. Shaft— $\frac{1}{4}$ " diameter round shaft, $1\frac{1}{8}$ " beyond end of bushing. Hardware furnished.	Bushing— $\frac{3}{8}$ "-32 thread, $\frac{3}{8}$ " long. Shaft— $\frac{1}{4}$ " diameter round shaft, $1\frac{1}{8}$ " beyond end of bushing. Hardware furnished.
MILITARY APPLICATIONS	Both types 212 and M-212 meet requirements of MIL-S-3786A, type SRO-3.	

### EXCLUSIVE MILITARY GRADE CTS-IRC STARWHEEL SHAFT AND 30° DETENT ASSEMBLY



T-180

T-181

T-182

A balanced lever arm and star wheel detent assembly free from end and side thrust is available for precision military and instrumentation applications. Star wheel detent provides extremely long life and minimum turning torque variation. Double lever arm construction controls torque in both directions of rotation with practically no change in torque during 100,000 cycles of operation through 12 switch positions.

# ROTARY SELECTOR SWITCHES

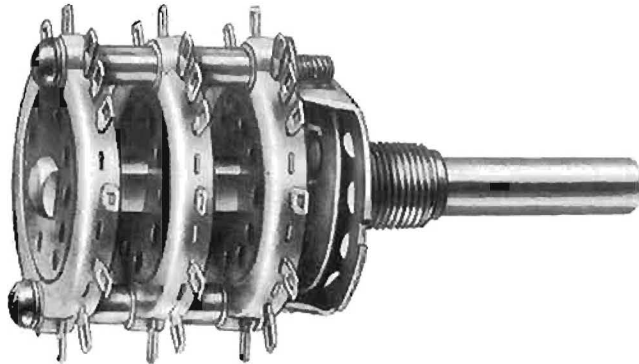

## ELECTRICAL RATING

### Voltage and Current Ratings:

1 amp at 28 volts DC

1½ amps at 115 volts AC

### High Pot Test:

Between adjacent 30° terminals or terminals to ground: 1,750 volts AC RMS

for one minute, Between adjacent 15° terminals: 750 volts AC RMS for one minute.

## 212 Wafer Assembly

The wafer assembly of the IRC-CTS selector switch can be separated into three basic elements, the rotor insulator, the rotor contacts and the stator. The stator consists of the stator insulator, terminal lugs, contacts, contact ring, which is made as a single unit.

### Stator Insulator

The stator insulator is a circular molding which encloses the mid portion of each contact and serves as a container for the rotor. The stator insulator also serves as a natural solder and flux barrier, thus protecting the contact areas.

### Contact Resistance

Circuit resistance ranges from .003 to .004 ohms on standard switches when measured from one terminal to an adjacent terminal. When measured terminals are not adjacent, up to 180° apart, the resistance will measure higher due to the extra metal in the stator circuits. It is to be noted

### Contact Life:

Standard sterling silver laminated rotor contacts and brass silver plated stator provide reliable life for a minimum of

### Detent Rotational Life:

The standard 212 detent assembly (T79, T80, T81 & T82) has a rated life of 25,000 cycles through 12 positions and return.

## The Stator

The Stator is the heart of the IRC-CTS selector switch and determines the circuitry of the switch in conjunction with the location of the selected rotor contacts. The stator is actually a circuit pattern cut out of metal which forms the terminal lugs, center contact ring and the stator contact.

## Rotor

The rotor of the IRC-CTS selector switch holds the rotor contacts in place and carries the contacts from one position to another, providing controlled float which prevents open circuiting during severe shock or vibration.

that the circuit resistance check measures all the metal in the circuit. Thus actual resistance at the point of contact is considerably less than the measured resistance. In CTS assemblies, contact resistance is unusually stable throughout the switch life.

50,000 cycles through 12 positions and return without appreciable increase in contact resistance. (See detent life.)

The star wheel detent mechanism (T180, T181, & T182) has a rated life of 100,000 cycles through 12 positions and return.

## LONGER LIFE CONTACTS

- After 1,100,000 index operations, life tests reveal virtually no change in rotor contact resistance.
- 1,000% more silver than used by most commercial switches has been evenly applied at actual point of contact by exclusive process. (See Sketch.)
- Rotor contacts are double-wiping and self-cleaning.
- Stator contacts are integral with terminals.

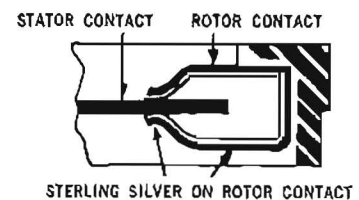



# ROTARY SELECTOR SWITCHES

IRC-CTS COMMERCIAL TYPE 212						
Total Poles	Number of Positions		Poles per Section	Number of Sections	Stock Number	
	Shorting	Non-Shorting			Shorting	Non-Shorting
1	2-11	2-12	1	1	T201	T205
2	2-5	2-6	2	1	T202	T206
3	2-3	2-4	3	1	T203	T207
4	2	2-3	4	1	T204	T208
6	2	2	6	1		T209
2	2-11	2-12	1	2	T211	T215
4	2-5	2-6	2	2	T212	T216
6	2-3	2-4	3	2	T213	T217
8	2	2-3	4	2	T214	T218
12	2	2	6	2		T219
3	2-11	2-12	1	3	T221	T225
6	2-5	2-6	2	3	T222	T226
9	2-3	2-4	3	3	T223	T227
12	2	2-3	4	3	T224	T228
18	2	2	6	3		T229
4	2-11	2-12	1	4	T231	T235
8	2-5	2-6	2	4	T232	T236
12	2-3	2-4	3	4	T233	T237
16	2	2-3	4	4	T234	T238
24	2	2	6	4		T239

IRC-CTS INDUSTRIAL-MILITARY TYPE M-212						
Total Poles	Number of Positions		Poles per Section	Number of Sections	Stock Number	
	Shorting	Non-Shorting			Shorting	Non-Shorting
1	2-11	2-12	1	1	T301	T305
2	2-5	2-6	2	1	T302	T306
3	2-3	2-4	3	1	T303	T307
4	2	2-3	4	1	T304	T308
6	2	2	6	1		T309
2	2-11	2-12	1	2	T311	T315
4	2-5	2-6	2	2	T312	T316
6	2-3	2-4	3	2	T313	T317
8	2	2-3	4	2	T314	T318
12	2	2	6	2		T319
3	2-11	2-12	1	3	T321	T325
6	2-5	2-6	2	3	T322	T326
9	2-3	2-4	3	3	T323	T327
12	2	2-3	4	3	T324	T328
18	2	2	6	3		T329
4	2-11	2-12	1	4	T331	T335
8	2-5	2-6	2	4	T332	T336
12	2-3	2-4	3	4	T333	T337
16	2	2-3	4	4	T334	T338
24	2	2	6	4		T339

WAFER SECTIONS	Total Poles	Number of Positions		Stock Number	
		Shorting	Non-Shorting	Shorting	Non-Shorting
COMMERCIAL WAFER SECTIONS	1	2-11	2-12	T1	T5
	2	2-5	2-6	T2	T6
	3	2-3	2-4	T3	T7
	4	2	2-3	T4	T8
	6	2	2		T9
INDUSTRIAL MILITARY WAFER SECTIONS	1	2-11	2-12	T101	T105
	2	2-5	2-6	T102	T106
	3	2-3	2-4	T103	T107
	4	2	2-3	T104	T108
	6	2	2		T109
DETENT ASSEMBLIES	Total Positions	Rear Shaft Length	Suggested Number of Sections	Stock Number	
STANDARD SHAFT & 30° DETENT ASSEMBLIES	2-12	7/32"	1	T79	
	2-12	1- 9/32"	1-3	T80	
	2-12	2-15/16"	4-5	T81	
STARWHEEL SHAFT & 30° DETENT ASSEMBLIES	2-12	5- 9/64"	7-10	T82	
	2-12	1- 9/32"	1-3	T180	
	2-12	2-15/16"	4-6	T181	
	2-12	5- 9/64"	7-10	T182	

TERMINAL SPECIFICATIONS	
1 Pole 11 Position Shorting Type T1 and T101	
2 Pole 5 Position Shorting Type T2 and T102	
3 Pole 3 Position Shorting Type T3 and T103	
4 Pole 2 Position Shorting Type T4 and T104	
1 Pole 12 Position Non-Shorting Type T5 and T105	
2 Pole 6 Position Non-Shorting Type T6 and T106	
3 Pole 4 Position Non-Shorting Type T7 and T107	
4 Pole 3 Position Non-Shorting Type T8 and T108	
6 Pole 2 Position Non-Shorting Type T9 and T109	

# ROTARY SELECTOR SWITCH ACCESSORIES



## IRC-CTS ATTACHABLE POWER SWITCHES

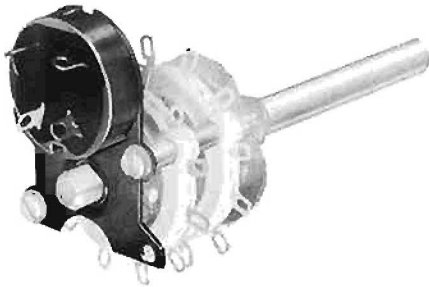

A selection of reliable AC power switches is available for use with selector switches, giving an original source for both the selector switch and attached switches. These power switches can be mounted on the rear frame of the selector switch or between wafers by means of a specially designed bracket.

STOCK NO.	DESCRIPTION	VOLTAGE	CURRENT
GC-21	SPST	125	3 Amps
VF-21	SPDT	125	3 Amps
WF-21	DPST	125	3 Amps

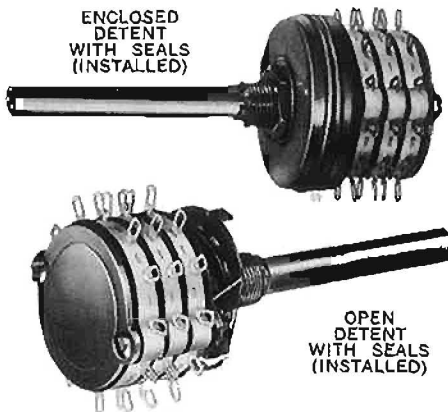

## SEALED SWITCH KITS

STOCK NO.	DESCRIPTION
SSK-1	Enclosed detent construction seals both the wafer sections and the detent mechanism of the switch against dust, dirt, and moisture.
DSWK-1	Open detent construction protects and seals the wafer sections of the selector switch against dust and dirt.

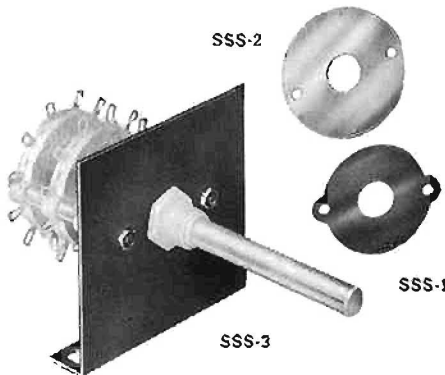

## SHIELDS AND MOUNTING BRACKETS

Shielding of switch sections from each other may be accomplished with these Switch Shields.

STOCK NO.	DESCRIPTION
SSS-1	Standard Shields
SSS-2	Brass, Silver Plated Shields
SSS-3	Combination Shields and Mounting Brackets



## IRC-CTS ROTARY SELECTOR SWITCH ENGINEERING LAB STOCK

The ELS-8 Rotary Selector Switch Lab Stock affords you the versatility of a combination for every application. The Lab Stock consists of:

- 75 Wafer Sections 30 Detent Assemblies
- Three Power Switches
- 2 Switch Seal Kits
- 15 Shields
- Includes Metal Cabinet and Labels



# KODAK SOUND RECORDING TAPES



Whatever your recording needs there is a KODAK Tape to do the job. For a general-purpose tape with low-print characteristics, choose Type 31A. Type 34A is a high-output tape which can also be used as a low-noise tape if record levels can be adjusted. For longer-playing applications try Types 21A and 21P (extra play) or Type 11P (double play). And now, Type 12P for triple-play. You'll find KODAK Sound Recording Tapes are available in a complete range of sizes and windings for amateur and professional use.

- **KODAK MEANS QUALITY.** The only professional quality tapes available at popular tape prices. Two great types . . . Professional Low Print-Through and Professional High Output. Both are lifetime coded to identify the brand and provide convenient indexing.
- **CONSISTENT UNIFORMITY** due to Eastman Kodak's exclusive emulsion process, consistent high quality is maintained from batch to batch and from reel to reel.
- **NO STRETCH.** New DUROL® base material is the Eastman Kodak's cellulose triacetate that is smooth, tough and durable. Breaks are clean . . . splices are made quickly, easily with minimum program loss.
- **NEW BINDER MATERIAL.** Coatings of "R-type" binder give a smoother, tougher recording surface that reduces tape noise and distortion. It is extremely abrasion resistant, preventing oxide build-up at the recording head.
- **THREAD EASY REEL** loads fast and easy. Rugged one-piece construction has indexing scale, built-in splicing jig and handy writing surface for tilting or identification. Supplied at no extra charge with all 5 and 7 inch rolls of KODAK Tape.
- **DURABLE LIBRARY CONTAINER.** Tough one-piece construction means package won't come apart even with heavy usage.

	DESCRIPTION	CAT. NO.	SIZE	REEL*
STANDARD PLAY	1½ MIL PLASTIC—Low Print-Through and other excellent performance characteristics. Ideal for general-purpose and master recordings. Type 31A base is Durol—a high strength cellulose triacetate plastic-type support material.	31A1	¼" x 150'	3" plastic reel in mailing box 5" plastic "Thread Easy" 7" plastic "Thread Easy" Metal NAB hub 10½" metal NAB hub and flange Plastic NAB hub (unboxed) Plastic NAB hub Plastic NAB hub (unboxed)
		31A6	¼" x 625'	
		31A12	¼" x 1250'	
		31A25MH	¼" x 2500'	
		31A25HF	¼" x 2500'	
		31A25PHB	¼" x 2500'	
		31A25PH	¼" x 2500'	
31A50PHB	¼" x 5000'			
HIGH OUTPUT	1½ MIL PLASTIC—High Output with remarkable low print-through. Professional performance Specifications. Type 34A base is Durol high strength triacetate designed to minimize distortion under high tension.	34A12	¼" x 1250'	7" plastic "Thread Easy" Metal NAB hub 10½" metal NAB hub and flange Plastic NAB hub (unboxed) Plastic NAB hub Plastic NAB hub (unboxed)
		34A25MH	¼" x 2500'	
		34A25HF	¼" x 2500'	
		34A25PHB	¼" x 2500'	
		34A25PH	¼" x 2500'	
34A50PHB	¼" x 5000'			
EXTRA PLAY	1 MIL PLASTIC—Longer play with Durol strength and good low print-through without sacrifice of excellent general-purpose features.	21A9	¼" x 900'	5" plastic "Thread Easy" 7" plastic "Thread Easy"
		21A18	¼" x 1800'	
EXTRA PLAY	1 MIL POLYESTER—Polyester base for strength—new "R-Type" binder for outstanding sound recordings.	21P9	¼" x 900'	5" plastic "Thread Easy" 7" plastic "Thread Easy"
		21P18	¼" x 1800'	
DOUBLE PLAY	½ MIL POLYESTER—Extra thin and treated for extra strength. Longer length for more playing time.	11P4	¼" x 400'	3" plastic reel in mailing box 5" plastic "Thread Easy" 7" plastic "Thread Easy"
		11P12	¼" x 1250'	
		11P25	¼" x 2500'	
TRIPLE PLAY	½ MIL POLYESTER—Triple play with superior print-through ratio. No sacrifice of general purpose performance.	12P6	¼" x 600'	3¼" plastic reel in mailing box 5" plastic "Thread Easy" 7" plastic "Thread Easy"
		12P18	¼" x 1800'	
		12P36	¼" x 3600'	

\* Unique Library Box only available with 5" & 7" size reels.

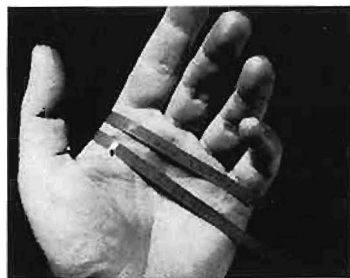

EASTMAN KODAK means quality. The only professional quality tapes available at popular tape prices. Two great types . . . Professional Low Print-Through and Professional High Output. Both are lifetime coded to identify the brand and provide convenient indexing.

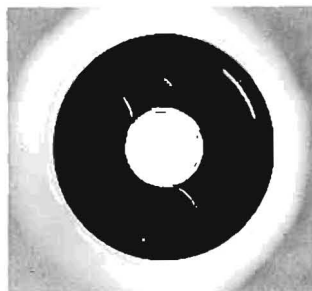

Thread Easy Reel loads fast and easy. Rugged one-piece construction has indexing scale, built-in splicing jig and handy writing surface for tilting or identification.

# VINYL ELECTRICAL TAPE



- Saves space in confined areas . . . ends "twice-around" wraps with bulky tapes,
- Provides a tight insulated plastic seal . . . resistant to abrasion, water, acids, alkalies, corrosion and aging.
- Gives a neater wrap . . . adheres readily to irregular surfaces and contours.
- Makes an excellent wrap for insulating tools.

**TAPE-AND-TEAR DISPENSER.** For one-hand taping IRC Vinyl Electrical Tape comes in a sturdy tape-and-tear dispenser that keeps tape clean and prevents stretching. Cutting blade is shielded. Dispenser is loaded with 66 feet of 3/4" tape. Also Available in cellophane wrapped rolls:

STOCK NUMBER	SIZE	PACKAGING
VT 104 "All-Weather"	3/4" x 66'	Dispenser
VT 103	3/4" x 66'	Dispenser
VT 103	3/4" x 20'	Cellophane Wrapped
VT 103	3/8" x 20'	Cellophane Wrapped
VT 103	3/8" x 36 YDS.	Cellophane Wrapped

## PROPERTIES OF IRC VINYL ELECTRICAL TAPE

	GENERAL PURPOSE TYPE 103	ALL-WEATHER TYPE 104
<b>PHYSICAL PROPERTIES</b>		
Thickness .....	.007"	.0085"
Tensile Strength .....	19 lb./in. of width	22 lb./in. of width
Elongation at Break .....	150%	200%
Adhesion to Steel .....	32 oz./in. of width	20 oz./in. of width
Low Temperature (4 hrs. @ 0°F) .....		Unrolling & Application Satisfactory
<b>ELECTRICAL PROPERTIES</b>		
Dielectric Strength .....	10,000v/mil (min.)	10,000v/mil (min.)
Power Factor @ 60 Cycles .....	.07	.07
Power Factor @ 10 <sup>6</sup> Cycles .....	.03	.03
Dielectric Constant at 60 Cycles .....	3.2	3.2
Dielectric Constant at 10 <sup>6</sup> Cycles .....	2.3	2.3
Insulation Resistance .....	Over 10 <sup>6</sup> Megohms	Over 10 <sup>6</sup> Megohms
Electrolytic Corrosion Factor .....	1.0	1.0
Resistance to Penetration at Elevated Temperatures .....	90°C (Avg.)	90°C (Avg.)
<b>CHEMICAL PROPERTIES</b>		
Sunlight .....	Not Affected	Not Affected
Corrosive Effect on Electrical Conductors .....	None	None
Resistance to Water .....	Excellent	Excellent
Resistance to Acids .....	Excellent	Excellent
Resistance to Alkalies .....	Excellent	Excellent
Resistance to Oils .....	Excellent	Excellent
Resistance to Aging at Room Temperature .....	Excellent	Excellent

Both Types 103 and 104 Meet MIL-I-7798A

**SAVES TIME.** Quicker than friction and rubber tape combinations. Takes only one operation instead of two. Adheres readily to irregular surfaces and contours. Makes a neater job.



# CONTROL CLEANER



IRC Stock No. CC-1

**STOPS NOISY  
OPERATION OF  
CONTROLS & SWITCHES**

## IRC ELECTRONIC CONTROL CLEANER CLEANS, LUBRICATES & PROTECTS:

- Volume Controls
- Tuners
- Switches
- Relays
- Contacts
- Circuit Breakers
- Other Sensitive Components

## FEATURES:

- Long-lasting protection against damaging corrosion and oxidation
- Removes dirt and clogging gum
- Deposits a non-drying film that lubricates contact surfaces
- Non-toxic—does not contain carbon tet
- Non-flammable
- Non-conductive—does not cause shorts
- Free 5" plastic extender included with each can for pin-point applications
- Works up-side-down for hard-to-reach places

## APPLICATIONS INCLUDE:

- Radio & TV
- Switchboards
- Vending Machines
- Timers
- Computers
- And wherever electrical contacts are found

**ECONOMICAL — 7 FULL OUNCES SELLING AT THE  
USUAL PRICE OF 6 OUNCE CANS**

**USE IRC CONTROL CLEANER FOR BRAND NAME ASSURANCE**

# DIODE & TRANSISTOR REFERENCE BOOKS



## DATADEX DIODE REFERENCE BOOK

- Over 260 pages of useful diode information
- Interchangeability guide for more than 3000 types
- Diode theory
- Circuits & circuit descriptions
- Diode indexing by parameters
- Price information
- Diode testing and handling procedures
- Actual size case outlines and dimensions

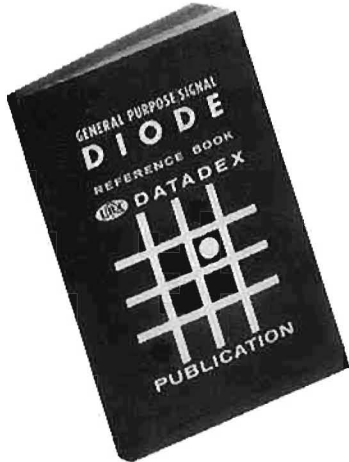

IRC No DS-1

This first edition contains information on:  
 General Purpose Signal Diodes  
 Microwave Mixer and Detector Diodes  
 Photo-Sensitive Diodes  
 Tunnel and Back Diodes  
 Varactor Diodes  
 Variable Capacity Diodes  
 Unijunction Transistors

### DATADEX SYSTEM OF DIODE IDENTIFICATION BY PARAMETERS

The Datadex identification system helps the user locate a semiconductor device for a particular application without having to search a myriad of manufacturers' specification sheets to find the right type number. Datadex includes a complete index of identification numbers which describe diode characteristics such as average forward current, peak operating voltage, and recovery time. An interchangeability guide lists corresponding JEDEC type numbers.

EXAMPLE: Datadex number 1D32E4

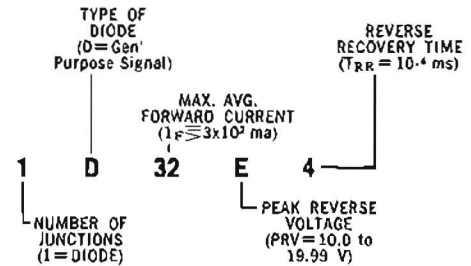

## DATADEX TRANSISTOR REFERENCE BOOK

- 300 pages of useful transistor information
- Interchangeability guide for more than 5000 types — including foreign makes
- Transistor theory
- Circuits & circuit descriptions
- Transistor indexing by parameters
- Price information
- Transistor testing and handling procedures



IRC No. DT-2

The second edition contains theory, circuit, and data sections on field-effect transistors.

### DATADEX SYSTEM OF TRANSISTOR IDENTIFICATION BY PARAMETERS

The Datadex identification system helps the user locate a semiconductor device for a particular application without having to search a myriad of manufacturers' specification sheets to find the right type number. Datadex includes a complete index of identification numbers which describe transistor characteristics by indicating the type and number of junctions, the maximum power, voltage, and frequency cutoff ratings. An interchangeability guide lists corresponding JEDEC type numbers.

EXAMPLE: Datadex number 2N32E4

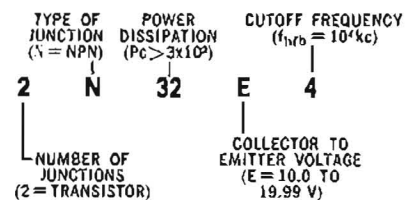





# INDEX

	Page		Page
AQ, AQ-5	25	P1-017 thru P25-121	26, 27
AW10 thru AW10,000	33	P115R100A thru P115R502A	32
AWP, AWP-5	25	PPQ11-103-SK7 thru PPQ19-137X-SK8	22
AWRL10 thru AWRL10,000	33	PQ	25
BU1 thru BU15	14	PQ11-103 thru PQ14-123	30
BS1 thru BS5	26	PW5	8
BWH	3, 4, 5	PW5X10 Asst.	8
C3	24	PW5X20	8
CC-1	46	PW10	8
CF1 thru CF70	13	PWP	25
CR1 thru CR50T	14	Q11-103 thru Q19-139X	21, 22
D	18	QCB thru QCP	24
D4 thru D7	9	QJ-3	39
DC1, DC2	16	QVC-539X	22
DCC	11	R1-024 thru R26-315	26, 27
DCF	5, 11	R2 thru R7	25
DCH	11	RA20, RA30	34
DM	11	RA20LASB100A thru RA20LASB752A	34
DS-1	47	RA20LASD101A thru RA20LASD752A	34
DSWK-1	43	RA20NASD100A thru RA20NASD752A	34
DT-2	47	RA30LASB100A thru RA30LASB752A	34
ELS1, ELS2	20	RA30NASD100A thru RA30NASD752A	34
ELS-8	43	RC07	2
FR5.0 thru FR7.5	8	RC20	2
GBT $\frac{1}{4}$	2	RC32	2
GBT $\frac{1}{2}$ , GBT1	2, 4, 5	RC42	2
GC	16	RQ	25
GC-21	43	RQ11-103 thru RQ14-123	30
JQ	25	RQL11-103 thru RQL13-139	30
HCL-1 thru HLC-6	39	RV2 thru RV6	34, 35
K	16	RV2LAYS101A thru RV2LAYS504A	35
K-2 thru K-18	26	RV2LAXSA101A thru RV2LAXSA504A	35
KA1	16, 25	RV2NAXSD101A thru RV2NAXSD504A	35
LC-2	39	RV2NAYSD101A thru RV2NAYSD504A	35
LP4A thru LP500A	38	RV4LAYS101A thru RV4LAYS505B	35
M11-103 thru M17-140	30	RV4LAYSD101A thru RV4LAYSD504A	35
M45A104 thru M45A504	19	RV4NAYSD101A thru RVDNAYSD505B	35, 36
M45D102 thru M45D505	19	RV5LAXSB102A thru RV5LAXSB504A	35
M-212	40, 42	RV5LAYS102A thru RV5LAYS504A	35
MC102D thru MC504D	33	RV5NAXSD102A thru RV5NAXSD504A	35
MC103AS thru MC504AS	33	RV5NAYSD102A thru RV5NAYSD504A	35
MDA	11	RV6LAYS101A thru RV6LAYS504A	35
MDB	11	RV6NAYSD101A thru RV6NAYSD504A	35
MDC	11	S	18
MDF	11	S-008B	5
MDH	11	S1 thru S5	24
MR1 thru MR5	8	S6 thru S52	28
N1 thru N4	25	SF1 thru SF34	16
NQ	25	SKI thru SK9	25

# INDEX



	Page		Page
SQ .....	25	8½H .....	6
SR¼ .....	2	8½HA .....	7
SR1 thru SR110 .....	16	10½H .....	6
SR2 .....	2, 4, 5	10½HA .....	7
SS1 thru SS16 .....	15	11P4 thru 11P25 .....	44
SSK-1 .....	43	12P6 thru 12P36 .....	44
SSS-1 thru SSS-3 .....	43	20A Asst .....	8
SWP .....	25	21A9, 21A18 .....	44
T1 thru T339 .....	42	21P9, 21P18 .....	44
T79 thru T82 .....	41, 42	25 25LT .....	34
T180 thru T182 .....	40, 41, 42	31A1 thru 31A50PHB .....	44
TM1 thru TM10 .....	24	34A12 thru 34A50PHB .....	44
TP4A - TP500A .....	38	41 Asst. ....	4
TQ .....	25	42 Asst. ....	5
U201R101B thru U201R504B .....	32	43 Asst. ....	5
VF .....	16	45 Asst. ....	4
VF-21 .....	43	45A103 thru 45A504 .....	18
VQ .....	25	45C .....	18
VT103, VT104 .....	45	45D102 thru 45D505 .....	18
W11-010 thru W17-308 .....	23	46 Asst. ....	5
WF .....	16	47 Asst. ....	5
WF1 thru WF20 .....	13	49A Asst. ....	5
WF-21 .....	43	55 Asst. ....	8
WM .....	24	65, 65LT .....	35
WM50 thru WM10,000 .....	31	76-1 thru 76-12 .....	25
WP2 thru WP50,000 .....	31	77 Asst. ....	4
WPB, WPC .....	24	87 Asst. ....	17
WPK10 thru WPK50,000 .....	23	88 Asst. ....	17
WPRL2 thru WPRL50,000 .....	31	89 Asst. ....	17
WPS10X5 thru WPS10,000 .....	23	90 Asst. ....	29
WQ .....	25	90, 90LT .....	35
WW2J thru WW24J .....	10	91 Asst. ....	29
X201R101B thru X201R504B .....	32	92 Asst. ....	29
01 thru 20 .....	18	96, 96LT .....	35
1A .....	6	103, 104 .....	45
1¾A .....	6	110-1.5 thru 110-3000-350 .....	38
1¾AA .....	7	110C-10 thru 110C-150 .....	38
2C .....	6	110D-75-60, 110D260-90 .....	38
2D .....	6	112-50 thru 112-10K .....	38
2DA .....	7	117R100A thru 117R502A .....	32
3A Asst .....	5	212 .....	40, 41, 42
4A Asst .....	5	252, 252LT .....	34
4D .....	6	300, 300LT .....	35
4DA .....	7	320, 320LT .....	35
5A Asst. ....	5	321, 321LT .....	35, 36
5EA .....	7	321LT102A thru 321LT504A .....	36
6A Asst .....	5	321S102A thru 321S504A .....	36
6½E .....	6	441 thru 444 .....	24
6½EA .....	7	5308 thru 6403 .....	37



IRC, INC., CONSUMER AND DISTRIBUTOR PRODUCTS DIVISION  
414 N. 13TH STREET, PHILADELPHIA, PA. 19108  
(215) WA 2-8900 • TWX 215-569-8720